



TAIDOC
INTERNATIONAL

- ✦ *Plastic Surgery*
- ✦ *Maxillo Facial*
- ✦ *Rhinoplasty*
- ✦ *Micro Surgery*



get the look

& ***confidence***

you have been looking for



FACE LIFT SCISSORS

Gorney Face Lift Scissors

Tungsten carbide edges

Straight	Curved	Length
TI-SS-O1-17	TI-SC-O1-17	17cm/6¾"
TI-SS-O2-19	TI-SC-O2-19	19cm/7½"
TI-SS-O3-23	TI-SC-O3-23	23cm/9"

Flat Tip



Gorney-Freeman Face Lift Scissors

Tungsten carbide edges - Open shanks

Straight	Curved	Length
TI-SS-O4-17	TI-SC-O4-17	17cm/6¾"
TI-SS-O5-19	TI-SC-O5-19	19cm/7½"
TI-SS-O6-23	TI-SC-O6-23	23cm/9"

Flat Tip



Kaye Face Lift Scissors

Tungsten carbide edges - Curved

Code	Length
TI-SC-O7-17	17cm/6¾"
TI-SC-O8-19	19cm/7½"
TI-SC-O9-23	23cm/9"



Aufricht Scissors

Tungsten carbide edges - Curved

TI-SC-10-14	Code
14cm/5¼"	Length



Goldman-Fox Scissors

- Tungsten carbide edges
- 13cm/5" length
- Tapered blades to fine tips
- Curved

TI-SC-11-13



Ragnell (Kilner) Scissors

- Tungsten carbide edges
- Curved flat tips

Code Length

TI-SC-12-13	13cm/6¾"
TI-SC-13-15	15cm/7½"
TI-SC-14-18	18cm/9"



Greenberg PAR Scissors

- 11.5cm/4¼" length
- Tungsten carbide edges
- Curved tapered flat tips

TI-SC-15-115



Little Plastic Surgery Scissors

- 12cm/4¾" length
- Curved
- Hole in the blades for the suture to be threaded through

TI-SC-16-12



Kahn Face Lift Scissors

- 14.5cm/5¾" length
- Super Cut edges
- Curved

TI-SC-17-145



Fomon Saber Face Lift Scissors

- 13.5cm/5¼" length
- Super Cut edges
- Curved, round blunt tips

TI-SC-18-135



MICRO SCISSORS SERRATED CUTTING EDGE

Iris Scissors

- 11.5cm/4½" length
- Straight
- Micro serrated cutting edge

TI-SS-19-115



Iris Scissors

- 11.5cm/4½" length
- Curved
- Micro serrated cutting edge

TI-SC-20-115

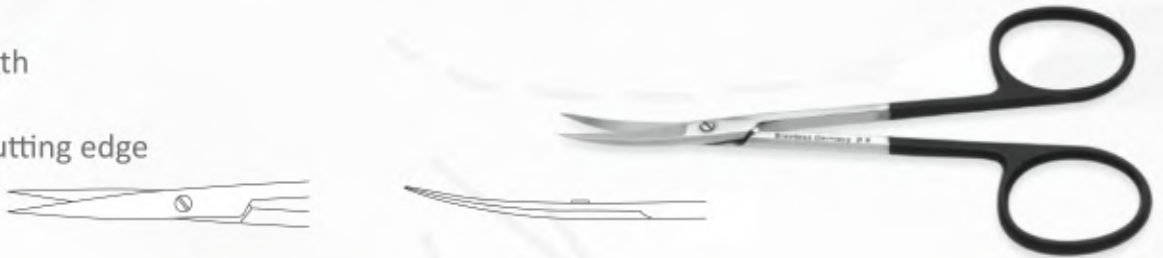

Strabismus Scissors

- 11.5cm/4½" length
- Straight
- Micro serrated cutting edge

TI-SS-21-115



Strabismus Scissors

- 11.5cm/4½" length
- Curved
- Micro serrated cutting edge

TI-SC-22-115



Waldram Scissors (with larger bows)

- 12.5cm/5" length
- Curved
- Micro serrated cutting edge

TI-SC-23-125



NEEDLE HOLDERS

Micron Fine Needle Holder

- 12.5cm/5" length
- Diamond dusted jaws

TI-NH-24-125



Derf Needle Holder

- 12cm/4¾" length
- Tungsten carbide jaws



TI-NH-26-12

TI-NH-27-12



Halsey Needle Holder

- 13cm/5" length
- Tungsten carbide jaws



TI-NH-28-13

TI-NH-29-13



Crile Wood Needle Holder

- Tungsten carbide jaws

15cm/6"

18cm/7"

20cm/8"



TI-NH-30-15

TI-NH-31-18

TI-NH-32-20

DISSECTING FORCEPS

Gillies Dissecting Forceps

- 15cm/6" length
- Toothed

TI-DF-33-15



McIndoes Dissecting Forceps

- 15cm/6" length
- Non Toothed

TI-DF-34-15



Debakey-Diethrich Tissue Forceps

- 15cm/6" length
- 1.5mm Tip

TI-DF-35-15



Debakey Tissue Forceps

- 15cm/6" length
- 2mm Tip

TI-DF-36-15



Adson Forceps

- 12cm/4¾" length
- Non toothed

TI-DF-37-12



Adson Forceps

- 12cm/4¾" length
- Toothed

TI-DF-38-12



Adson Forceps

- 12cm/4¾" length
- 7x7 teeth

TI-DF-39-12



Senn-Miller Double Ended Retractor

- 16cm/6¼" length

TI-RE-40-16 Sharp prongs

TI-RE-41-16 Blunt prongs



Gillies Skin Hook

- 18cm/7" length

TI-RE-42-18 Small

TI-RE-43-18 Large



Klienert-Kutz Skin Hook

- 16cm/6¼" length

TI-RE-44-16 Small

TI-RE-45-16 Large



Joseph Double Skin Hook

- 16cm/6¼"

TI-RE-46-16



Rollet/Blair Mini-Catspaw Retractor

- 13.5cm/5" length
- Semi-sharp prongs

TI-RE-47-135



Catspaw Retractors

- 16cm/6¼" length
- Semi-sharp prongs

TI-RE-48-16

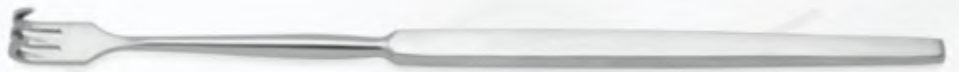

Desmarres Saddle Retractor

- 16cm/6¼" length
- 8mm width
- 10mm width
- 12mm width
- 14mm width

TI-RE-49-16



DISSECTORS - SKIN GRAFT KNIVES

Freers Elevator/Dissector

- 18.5cm/7¼" length

TI-DI-50-185



Watson Cheyne Dissector

Size

TI-DI-51-18

18cm/7"

TI-DI-52-23

23cm/9"

TI-DI-53-25

25cm/10"



MacDonald Elevator/Dissector

Size

TI-DI-54-19

19cm/7½"

TI-DI-55-23

23cm/9"



Howarth Elevator

- 21.5cm/8½" length

TI-DI-56-215



Humby Skin Graft Knife

- 36.5cm/14¼" length

Right Handle

TI-DI-57-365

Left Handle

TI-DI-58-365



The grooved roller bar rotates and oscillates from side to side. The graft thickness is controlled by adjusting the thumb screws on top of the support pillars.

NASAL INSTRUMENTS

Giunta Nasal Scissors

- 13.5cm/5¼" length
- Tungsten carbide edges
- Double angled blades

TI-NI-59-135



Daniels Nasal Scissors

- 10cm/4" length
 - 40° angled blades
- For dissection of Nasal Tip Cartilage

TI-NI-60-10



Heymann Nasal Scissors

- 18cm/7" length

TI-NI-61-18



Cottle Dorsal Scissors

- 16cm/6¼" length
- Tungsten carbide edges

TI-NI-62-16



Caplan Nasal Shears

- 20cm/8" length
- Double action angled

TI-NI-63-20



NASAL INSTRUMENTS

Kilner Alae Retractor

- 85mm length Diameter

Code	Blunt Spongs	Code	Sharp Spongs
TI-NI-64-10	10mm	TI-NI-67-10	10mm
TI-NI-65-13	13mm	TI-NI-68-13	13mm
TI-NI-66-15	15mm	TI-NI-69-15	15mm



Cottle Septum Elevator

- 20cm/8" length
- Double ended graduated

TI-NI-70-20



Masing Septum Elevator

- 20cm/8" length

TI-NI-71-20



Carter Septum Elevator

- 21cm/8¼" length
- Double ended with curette

TI-NI-72-21



Freer Mucosa Knife

- 15cm/6" length

TI-NI-72-15



Cottle-Neivert Alae Retractor

- 2 prong blunt ball tips
- Knife guard
- 20cm/8" length

TI-NI-72-20



Killian Speculum

- 13cm/5" length
- Plain blade

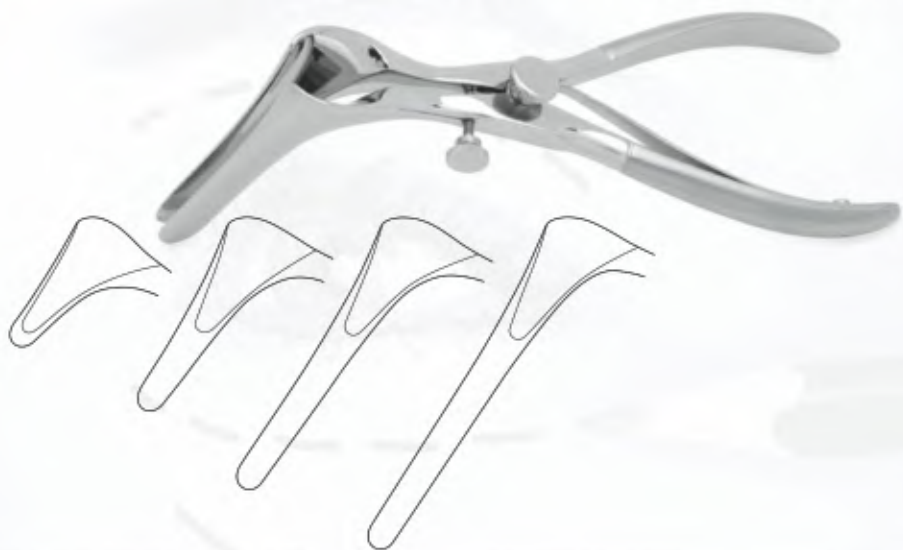

Code	Blade
TI-NI-73-13	35mm
TI-NI-74-13	55mm
TI-NI-75-13	65mm
TI-NI-76-13	75mm
TI-NI-77-13	90mm

Fomon Alae Retractor

- 16cm/6¼" length
- 2 prong blunt ball tips

TI-NI-78-16



Cottle Hook

- 14cm/5½" length
- 2 prong blunt ball and sharp tips



Sharp prongs
TI-NI-79-14



Ball on right
TI-NI-80-14



Ball on left
TI-NI-81-14



Cottle Retractor

- 15cm/6" length

TI-NI-82-15



Aufricht Nasal Retractor

- 16cm/6¼" length
- 45mm blade

TI-NI-83-16



Aufricht Nasal Retractor

- 16cm/6¼" length
- Fibre optic illumination
- 45mm blade

TI-NI-84-16



NASAL INSTRUMENTS

Joseph Nasal Saw

- 19cm/7" length



Straight

TI-NI-85-19



Cranked to right

TI-NI-86-19



Cranked to left

TI-NI-87-19

Joseph Nasal Saw

- Horizontal shaft
- 125mm x 85mm

Cranked right

TI-NI-88-125

Cranked to left

TI-NI-89-125



Ballenger Swivel Knife

- 19.5cm/7½" length
- Bayonet shaped

Code

With

TI-NI-90-195

3mm

TI-NI-91-195

4mm

TI-NI-92-195

5mm



Jansen Middleton Septum Forceps

- 19cm/7½" length
- Double action

TI-NI-93-19



Walsham Septum Straightening Forceps

- 23cm/9" length



Universal

TI-NI-94-23



Left

TI-NI-95-23



Right

TI-NI-96-23

Toffee Mallet

- 19cm/7½" length
- Head size 22mm Ø
- Weight 165g/6oz

TI-NI-97-19



Killian Septum Gouge

- Round cutting edge 6mm width
- 16cm/6¼" length
- Bayonet shaped

TI-NI-98-16



Notched cutting edge 6mm width

TI-NI-99-23

NASAL INSTRUMENTS

Gubisch Osteotome

- 18.5cm/7¼" length
- 3mm wide
- Aluminium handle

TI-NI-100-185



Cottle Chisel

- 18.5cm/7½" length

Code	With
TI-NI-101-185	4mm
TI-NI-102-185	6mm
TI-NI-103-185	7mm
TI-NI-104-185	8mm
TI-NI-105-185	9mm
TI-NI-106-185	12mm



Sheehan Osteotomes

- 15cm/6" length

TI-NI-107-15	Set of 5 sizes 2mm to 10mm
--------------	-------------------------------

Code	With
TI-NI-108-15	2mm
TI-NI-109-15	4mm
TI-NI-110-15	6mm
TI-NI-111-15	8mm
TI-NI-112-15	10mm



Matthew Osteotome

18cm/7" length

- 11mm wide
- Bevelled at one corner

TI-NI-113-18



Code	With
TI-NI-114-18	8mm
TI-NI-115-18	10mm
TI-NI-116-18	12mm
TI-NI-117-18	14mm
TI-NI-118-18	16mm



Rubin Osteotome

- 18cm/7" length

Fomon Double Ended Nasal Rasp

- 21cm/8¼" length
- Tungsten carbide surface

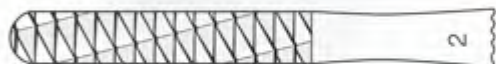

TI-RA-119-21 Course



TI-RA-120-21 Medium



TI-RA-121-21 Fine

MALTZ (Parkes) Nasal Rasp

- 18cm/7" length
- Tungsten carbide surface
- Backward cutting



Course
TI-RA-122-18



Fine
TI-RA-124-21



TI-RA-123-18 Medium

Maltz Nasal Rasp

- 18.5cm/7½" length
- TI-RA-125-185



Nievert Chisel with Guard

- 20cm/8" length



TI-RA-126-20 Straight TI-RA-127-20 Curved Left TI-RA-128-20 Curved Right

Silver Chisel with Guard (Frenchay)

- 18cm/7" length



TI-RA-129-18 Straight TI-RA-130-18 Curved Left TI-RA-131-18 Curved Right

Fomon Double Ended Nasal Rasp

- 21cm/8¼" length
 - Diamond surface
- TI-RA-132-21



Miller Nasal Rasp

- 18cm/7" length
- Tungsten carbide surface

TI-RA-133-18



MAXILLO FACIAL INSTRUMENTS

Disimpaction Forceps

- 18.5cm/7¼" length

Nasal blade



Oral blade



Tessier-Rowe Left

- 23cm/9" length
- For children

TI-MF-134-23

Oral blade



Nasal blade



Tessier-Rowe Right

- 23cm/9" length
- For children

TI-MF-136-23



Tessier-Rowe Left

- 23cm/9" length
- For adults

TI-MF-135-23



Tessier-Rowe Right

- 23cm/9" length
- For adults

TI-MF-137-23

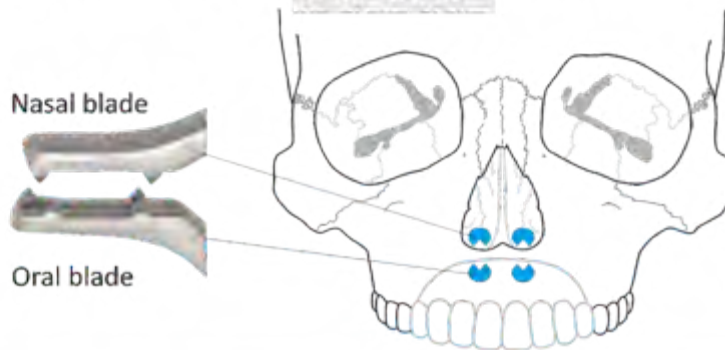

Tessier-Rowe Left Side

- 18cm/7" length

Oral blade

40mm

Nasal blade

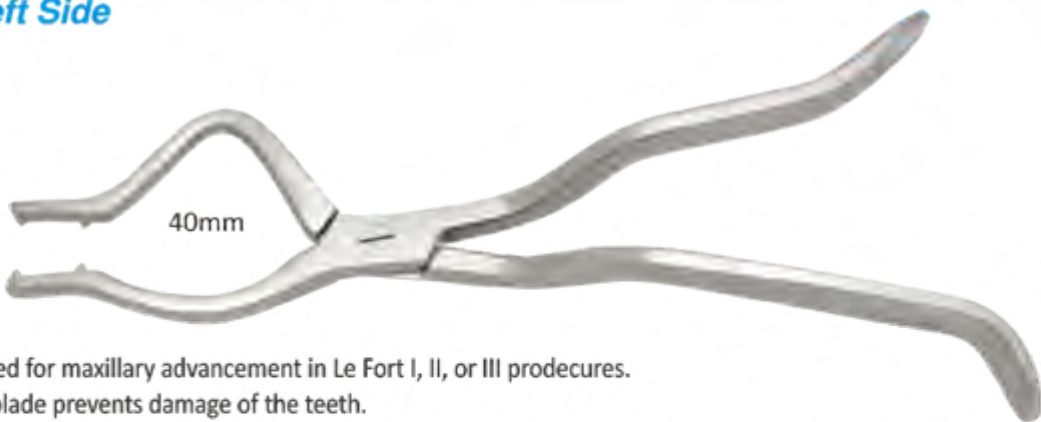

These instruments are used for maxillary advancement in Le Fort I, II, or III procedures.

A Large curvature of the blade prevents damage of the teeth.

The oral blades are asymmetrical to adapt to the curvature of the palate which is often high and concave.

Tessier-Rowe Right Side



Obwegeser Pterygoid Osteotome

- 23.5cm/9" length
- Curved

Code	Size
TI-OS-138-235	8mm
TI-OS-139-235	10mm
TI-OS-140-235	11mm

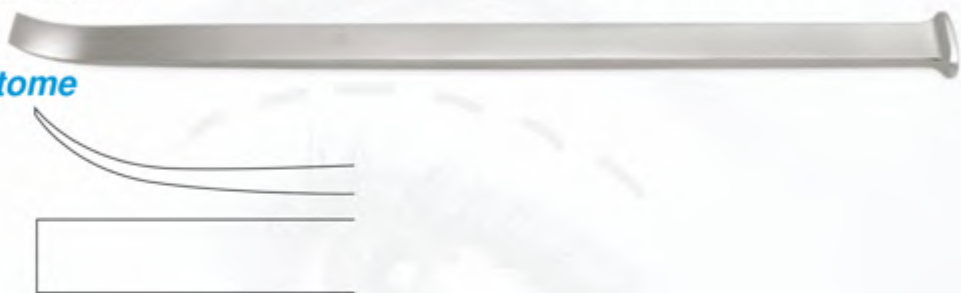

Obwegeser Splitting Osteotome

- 22cm/8¾" length
- Thin blade

Code	Size
TI-OS-141-22	8mm
TI-OS-142-22	10mm
TI-OS-143-22	11mm



Obwegeser-Ramus Wedge Osteotome

- 22cm/8¾" length
- Wedge profile

Code	Size
TI-OS-144-22	8mm
TI-OS-145-22	10mm
TI-OS-146-22	11mm



Ramus Split Osteotome Straight

- 22cm/8¾" length
- Thicker tapered blade

Code	Size
TI-OS-147-22	7mm
TI-OS-148-22	10mm



MICRO SURGERY INSTRUMENTS

Round Bodied Vessel Dilator

- 15cm/6" length
- Straight tips 0.3mm \emptyset
- Balanced forceps

TI-MS-149-15



Round Bodied Vessel Dilator

- 15cm/6" length
- Curved tips 0.2mm \emptyset
- Balanced forceps

TI-MS-150-15



Round Bodied Vessel Dilator

- 18cm/7" length
- Straight tips 0.3mm \emptyset
- Balanced forceps

TI-MS-151-18



Jewellers Forceps

- 11cm/4¼" length
- Tips 0.3mm

TI-MS-152-11



Jewellers Forceps Long

- 15cm/6" length
- Tips 0.3mm

TI-MS-153-15



Jewellers Forceps Long

- 12cm/4¾" length
- Tips 0.3mm

TI-MS-154-12



Jewellers Forceps

- 13.5cm/5¾" length
- Tips 0.3mm

TI-MS-155-135



Straight Scissors Round Handle

- 15cm/6" length **TI-MS-156-15**
- Blades 12mm long

- 18cm/7" length **TI-MS-157-18**
- Blades 14mm long



Adventitia scissors with pointed tips

Curved Scissors Round Handle

- 15cm/6" length **TI-MS-158-15**
- Blades 12mm long

- 18cm/7" length **TI-MS-159-18**
- Blades 14mm long



Dissecting scissors with rounded tips

Barraquer Micro Needle Holder

- Round bodied
- 0.4mm jaws

Without Lock	Straight	Curved
13cm/5"	TI-MS-160-13	TI-MC-160-13
15cm/6"	TI-MS-161-15	TI-MC161-15
18cm/7"	TI-MS-162-18	TI-MC162-18



Castroviejo Micro Needle Holder

- Flat handled
 - 0.4mm jaws
- | Without Lock | Straight |
|--------------|--------------|
| 14cm/5½" | TI-MS-163-14 |
| 18cm/7" | TI-MS-164-18 |



Straight Scissors Flat Handle

- 15cm/6" length
- Blades 19mm long **TI-MS-165-15**

Adventitia Scissors with pointed tips



TI-MS-166-19 Available with Micro Serrations for nerve cutting - Straight

Curved Scissors Flat Handle

- 15cm/6" length
 - Blades 19mm long **TI-MS-167-15**
- Dissecting Scissors with rounded tips
Available with Micro Serrations for nerve cutting - Straight



TI-MS-168-19

RHINOLOGY

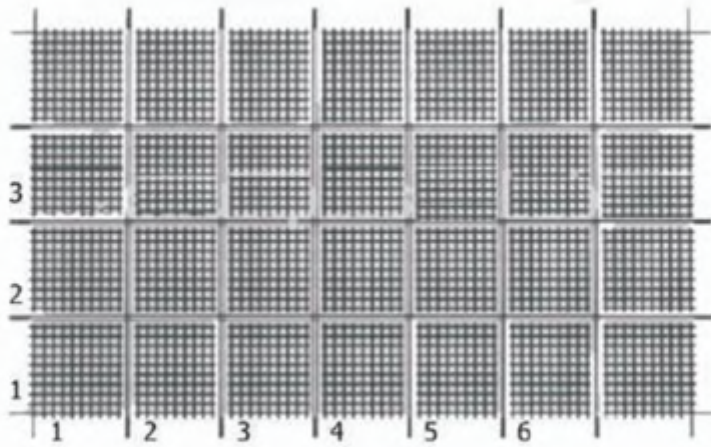

SHEEN
Aluminium grid
TI-RL-169-00



CHALAZION CLAMP
FORCEPS
TI-RL-170-8 8mm
TI-RL-171-12 12mm



COTTLE COLUMELLA
FORCEPS
TI-RL-172-8 8mm
TI-RL-173-12 12mm



KILLIAN NASAL SPECULUM
WITH FIBER OPTIC LIGHT 7.5CM



7.5 cm
TI-RL-175-75

6.5 cm
TI-RL-174-65



CALIPER
STRAIGHT
TI-RS-176-00



CALIPER
CURVED
TI-RC-177-00



Straight

TI-TU-178-25 2.5MM
TI-TU-179-30 3.0MM
TI-TU-180-35 3.5MM



Up 45°

TI-TU-181-25 2.5MM
TI-TU-182-30 3.0MM
TI-TU-183-35 3.5MM



Up 90°

TI-TU-184-00



Down

TI-TU-185-00



BLAKESLEY NASAL FORCEPS



Straight

TI-TU-186-00



Up 45°

TI-TU-187-00



THROUGH CUTTING PUNCH



TILLEY AURAL FORCEPS
TI-TU-188-00



LUC NASAL TURBINATE FORCEPS OVAL SHAPE



SMALL

TI-TUL-189-00



MEDIUM

TI-TU-190-00



LARGE

TI-TU-191-00

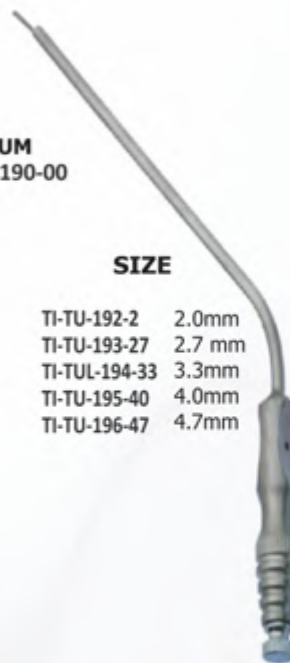

SIZE

TI-TU-192-2 2.0mm
TI-TU-193-27 2.7 mm
TI-TUL-194-33 3.3mm
TI-TU-195-40 4.0mm
TI-TU-196-47 4.7mm

LEMPERT MASTOID SUCTION TUBES



TI-TU-197-00
MALLEABLE SUCTION

OSTEOTOME & CHISELS



SIZE

- TI-OS-198-2 2mm
- TI-OS-199-3 3mm
- TI-OS-200-4 4mm
- TI-OS-201-5 5mm
- TI-OS-202-6 6mm

**MEASURING
OSTEOTOME**



**SILVER CHISEL
LEFT
TI-OS-203-00**



**SILVER CHISEL
RIGHT
TI-OS-204-00**



**SILVER CHISEL
STRAIGHT
TI-OS-205-00**



SIZE

- TI-OS-206-4 4mm
- TI-OS-207-5 5mm
- TI-OS-208-6 6mm

**TILLEY SEPTUM
GOUGE V-SHAPE**



SIZE

- TI-OS-209-4 4mm
- TI-OS-210-5 5mm
- TI-OS-211-6 6mm

**KILLIAN
NASAL GOUGE**



**ROZNER NASAL
OSTEOTOME**



SIZE

- TI-OS-212-6 6mm
- TI-OS-213-8 8mm
- TI-OS-214-8 10mm
- TI-OS-215-12 12mm

**GILLIES
CHISEL**

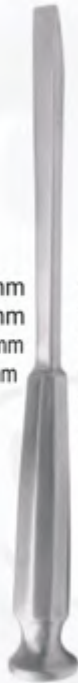

SIZE

- TI-OS-216-2 2mm
- TI-OS-217-3 3mm
- TI-OS-218-4 4mm
- TI-OS-219-6 6mm
- TI-OS-220-8 8mm
- TI-OS-221-10 10mm

**GILLIES
GOUGE**



SIZE

- TI-OS-222-2 2mm
- TI-OS-223-3 3mm
- TI-OS-224-4 4mm
- TI-OS-225-6 6mm
- TI-OS-226-8 8mm
- TI-OS-227-10 10mm

**GILLIES
OSTEOTOME**



STRAIGHT

- TI-OS-228-2 2mm
- TI-OS-229-3 3mm
- TI-OS-230-4 4mm
- TI-OS-231-6 6mm
- TI-OS-232-8 8mm
- TI-OS-233-10 10mm

CURVED

- TI-OS-234-2 2mm
- TI-OS-235-3 3mm
- TI-OS-236-4 4mm
- TI-OS-237-6 6mm
- TI-OS-238-8 8mm
- TI-OS-239-10 10mm



**OSTEOTOME
MOON TYPE**

SIZE

- TI-OS-240-8 8mm
- TI-OS-241-10 10mm
- TI-OS-242-12 12mm
- TI-OS-243-15 15mm



MALLET
TI-RR-244-00



MALLET WITH PLASTIC
TI-RR-245-00



V.P. SOOD AUFRIGHT
NASAL RETRACTOR
TI-RE-246-00



ASH SEPTUM
FORCEPS
TI-RR-247-00



Palate Dissector
RIGHT
TI-RE-248-00



R



L

Palate Dissector
LEFT
TI-RE-249-00



WANG RASPATORY
7 1/8"



WANG RASPATORY
STRAIGHT
TI-RE-250-00

HOOK AND RETRACTOR



COTTLE
RETRACTOR
BLUNT



COTTLE
RETRACTOR
SHARP



COTTLE UPPER
RETRACTOR



JOSEPH
RETRACTOR
FINE SHARP



GILLIES
SKIN HOOK



COTTLE UPPER
TEFLON COATED RETRACTOR
TI-RE-258-00



ROLLET RETRACTOR
4 SHARP PRONGS
TI-RE-259-00



KILNER
RETRACTOR



ANDERSON BEAR
CLAW RETRACTOR
5 PRONGS
TI-RE-262-00



ALAR
RETRACTOR
TI-RE-263-00



SKIN
RETRACTOR
TI-RE-264-00



Epstein Breast Retractors: developed to create a retractor that provides unparalleled exposure and simultaneously reduces the strain on the surgeon's shoulder while permitting an atraumatic dissection, resulting in less pain and bleeding.

By reversing the handle we have achieved a "power assist" by the assistant. The minimum blade length outside the wound reduces the leverage on the surgeon's shoulder.

The teeth surrounding the working end of the retractor ensures a gentle, yet firm hold on the tissue. The spatulated-end enables the surgeon to obtain maximal exposure at the point of surgical dissection.

TI-BR-265-00
Epstein Breast Retractor
90x27mm blade, w/36mm
spatulated working end with teeth

TI-BR-266-00
Epstein Breast Retractor
110x27mm blade, w/36mm
spatulated working end with teeth

TI-BR-267-00
Epstein Breast Retractor
140x27mm blade, w/36mm
spatulated working end with teeth

TI-BR-268-00
Epstein Breast Retractor
160x27mm blade, w/36mm
spatulated working end with teeth

TI-BR-269-00
Epstein Breast Retractor Set,
consisting of one each:
TI-BR-265-00-TI-BR-266-00
TI-BR-267-00-TI-BR-268-00

Also available with fiber optic, suction
and fiber optic/suction, please inquire

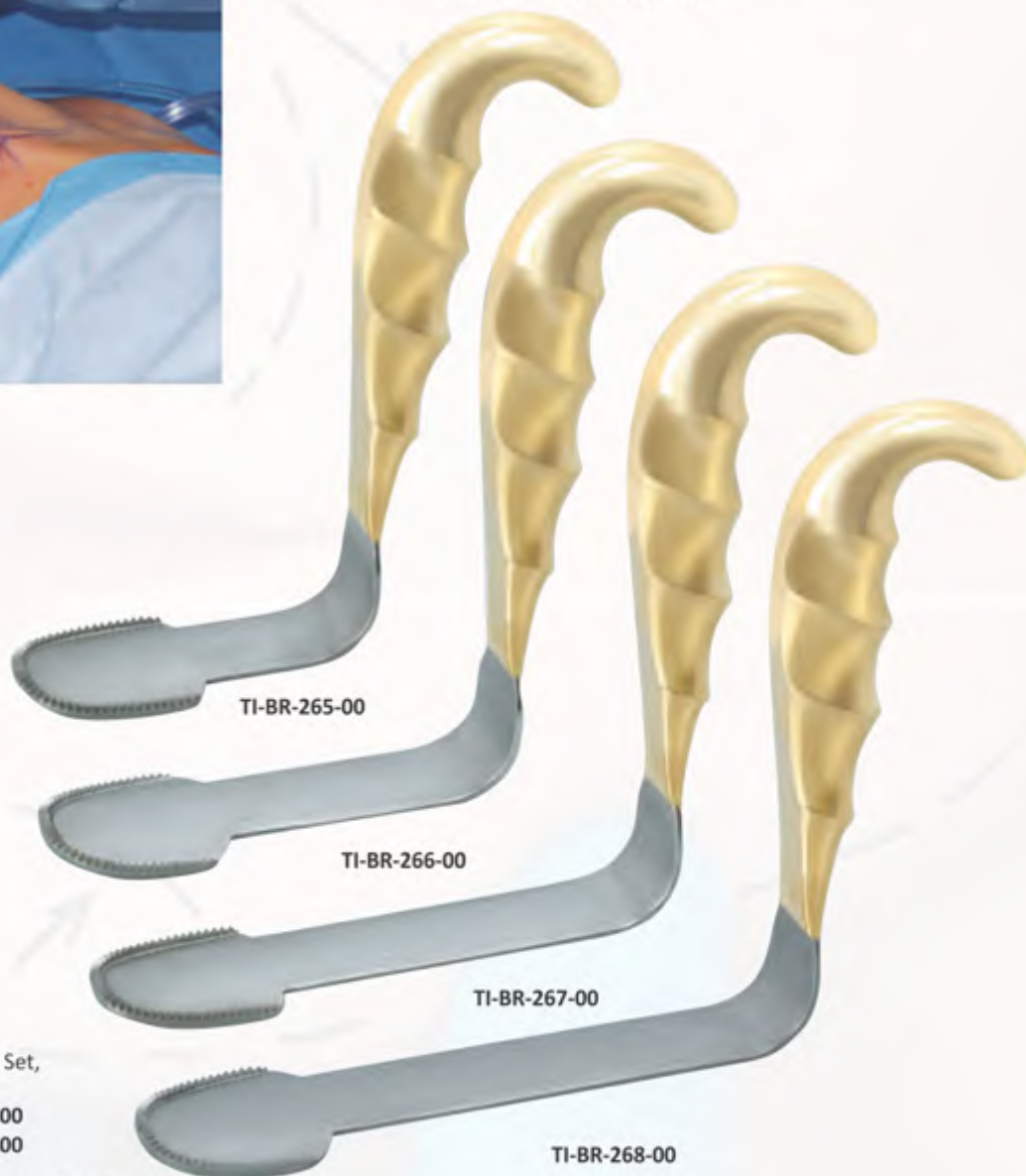

EPSTEIN BREAST RETRACTORS WITH FIBER OPTIC AND SUCTION

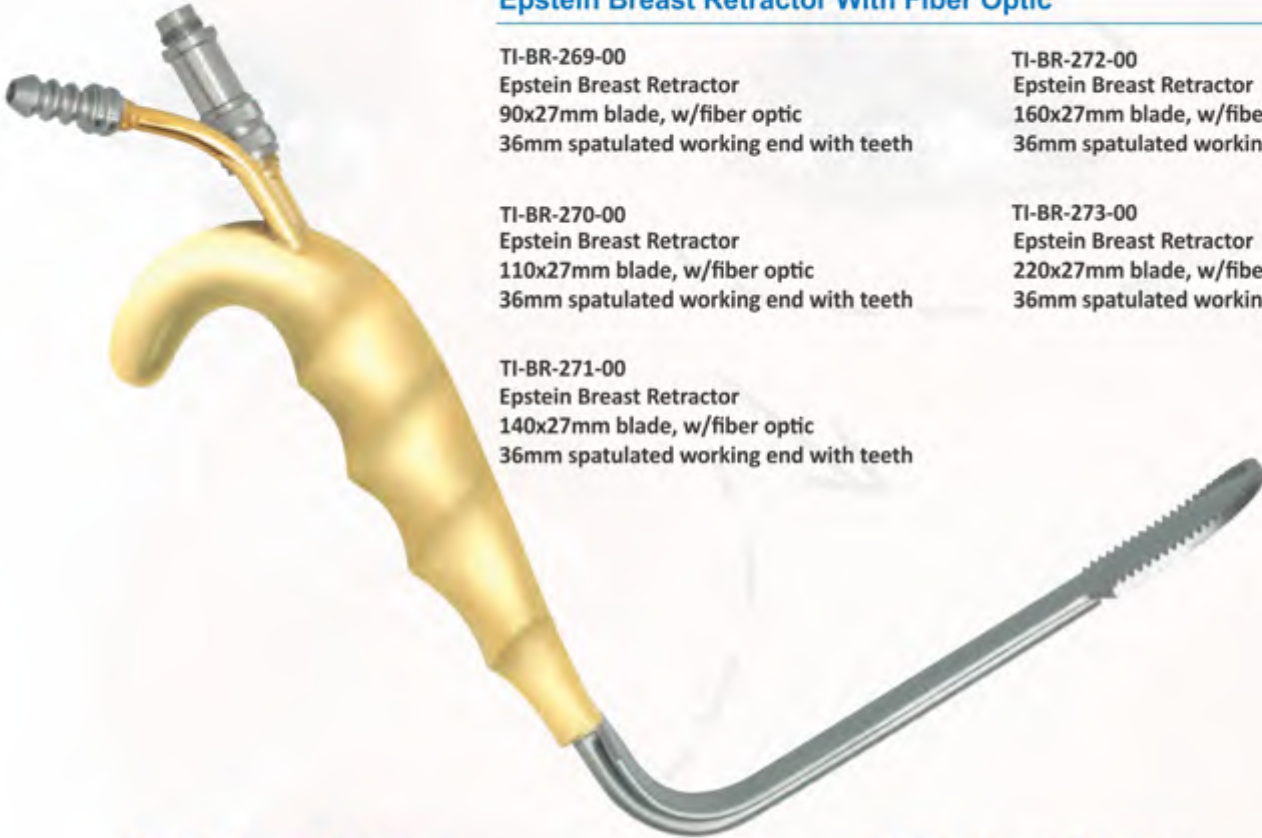

Epstein Breast Retractor With Fiber Optic

TI-BR-269-00
Epstein Breast Retractor
90x27mm blade, w/fiber optic
36mm spatulated working end with teeth

TI-BR-272-00
Epstein Breast Retractor
160x27mm blade, w/fiber optic
36mm spatulated working end with teeth

TI-BR-270-00
Epstein Breast Retractor
110x27mm blade, w/fiber optic
36mm spatulated working end with teeth

TI-BR-273-00
Epstein Breast Retractor
220x27mm blade, w/fiber optic
36mm spatulated working end with teeth

TI-BR-271-00
Epstein Breast Retractor
140x27mm blade, w/fiber optic
36mm spatulated working end with teeth

Epstein Breast Retractor With Fiber Optic & Reversed Suction Tube

TI-BR-274-00
Epstein Breast Retractor
90x27mm blade, w/fiber optic & reversed suction tube,
36mm spatulated working end with teeth

TI-BR-275-00
Epstein Breast Retractor
110x27mm blade, w/fiber optic & reversed suction tube,
36mm spatulated working end with teeth

TI-BR-276-00
Epstein Breast Retractor
140x27mm blade, w/fiber optic & reversed suction tube,
36mm spatulated working end with teeth

TI-BR-277-00
Epstein Breast Retractor
160x27mm blade, w/fiber optic & reversed suction tube,
36mm spatulated working end with teeth

Epstein Breast Retractor With Reversed Suction Tube

TI-BR-278-00
Epstein Breast Retractor
90x27mm blade, w/reversed suction tube,
36mm spatulated working end with teeth

TI-BR-279-00
Epstein Breast Retractor
110x27mm blade, w/reversed suction tube,
36mm spatulated working end with teeth

TI-BR-280-00
Epstein Breast Retractor
140x27mm blade, w/reversed suction tube,
36mm spatulated working end with teeth

TI-BR-281-00
Epstein Breast Retractor
160x27mm blade, w/reversed suction tube,
36mm spatulated working end with teeth

Provides Maximum Exposure and Vision for Small Incisions



Periareolar Incision, showing reach of retractor



Periareolar Incision, retractor in place

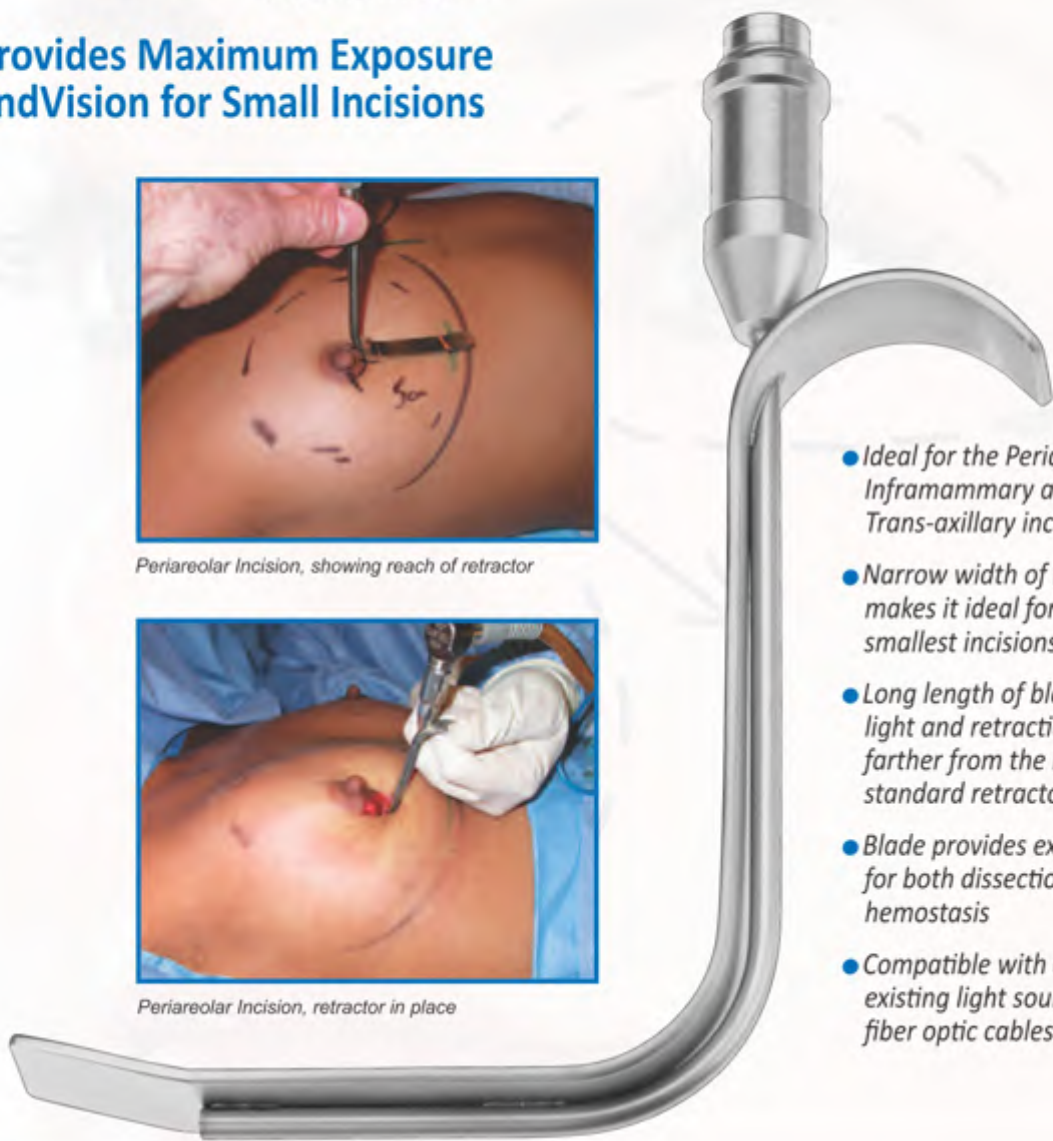

- *Ideal for the Periareolar, Inframammary and Trans-axillary incisions*
- *Narrow width of blade makes it ideal for use with the smallest incisions*
- *Long length of blade delivers light and retraction much farther from the incision than standard retractors*
- *Blade provides exposure for both dissection and hemostasis*
- *Compatible with all standard, existing light sources and fiber optic cables*

TI-BR-282-00
65mmx12mm wide blade
with Fiber Optic and Adapter

TI-BR-283-00
65mmx12mm wide blade
with Suction,
w/o Fiber Optic

TI-BR-284-00
65mmx12mm wide blade,
insulated,
with Fiber Optic and Adapter

TI-BR-285-00
65mmx12mm wide blade, w/o teeth,
w/o Fiber Optic and Suction

TI-BR-286-00
65mmx12mm wide insulated blade
with teeth, Fiber Optic and Adapter



STI-BR-287-00
65mmx12mm wide blade with teeth,
Fiber Optic and Adapter

TI-BR-288-00
65mmx12mm wide blade with teeth,
w/o Fiber Optic

BREAST RETRACTORS

TI-BR-289-00
WITH FIBER OPTIC,
SUCTION & ADAPTER

70x25mm wide blade

TI-BR-290-00
70x27mm wide blade

TI-BR-291-00
80x16mm wide blade

TI-BR-292-00
90x22mm wide blade

TI-BR-293-00
90x27mm wide blade



WITH FIBER OPTIC, SUCTION & ADAPTER **TI-BR-294-00**

TI-BR-295-00
110x20mm wide blade

TI-BR-296-00
110x22mm wide blade

TI-BR-297-00
110x25mm wide blade

TI-BR-298-00
120x25mm wide blade

TI-BR-299-00
130x16mm wide blade

TI-BR-300-00
150x16mm wide blade

TI-BR-301-00
150x20mm wide blade

TI-BR-302-00
150x25mm wide blade

TI-BR-303-00
150x30mm wide blade

TI-BR-304-00
180x16mm wide blade

TI-BR-305-00
180x25mm wide blade

TI-BR-306-00
190x25mm wide blade

TI-BR-307-00
190x36mm wide blade

TI-BR-308-00
220x27mm wide blade



WITH FIBER OPTIC,
SUCTION & ADAPTER
INSULATED AT WORKING END **TI-BR-309-00**

150x16mm wide blade WITH FIBER OPTIC,



SUCTION & ADAPTER
INSULATED

150x16mm wide blade
TI-BR-310-00
180x16mm wide blade



BREAST RETRACTORS

WITH FIBER OPTIC,
REVERSED SUCTION TUBE
& ADAPTER TI-BR-311-00

90x22mm wide blade

TI-BR-312-00
90x22mm Insulated blade



BLADE WITHOUT FIBER OPTIC,
SUCTION OR TEETH TI-BR-313-00

90x22mm wide blade

110x25mm wide blade
TI-BR-314-00

125x25mm wide blade
TI-BR-315-00

130x16mm wide blade
TI-BR-316-00

190x25mm wide blade
TI-BR-317-00



BLADE WITH TEETH TI-BR-319-00

125x25mm wide blade

TI-BR-320-00

130x16mm wide blade



BLADE WITH TEETH,
FIBER OPTIC,
REVERSED SUCTION TUBE
& ADAPTER TI-BR-321-00

90x22mm wide blade



BLADE WITH TEETH,
FIBER OPTIC,
SUCTION & ADAPTER TI-BR-322-00

- 80x16mm Insulated blade
- TI-BR-323-00
- 80x25mm Insulated blade
- TI-BR-324-00
- 110x25mm Insulated blade
- TI-BR-325-00
- 150x25mm Insulated blade

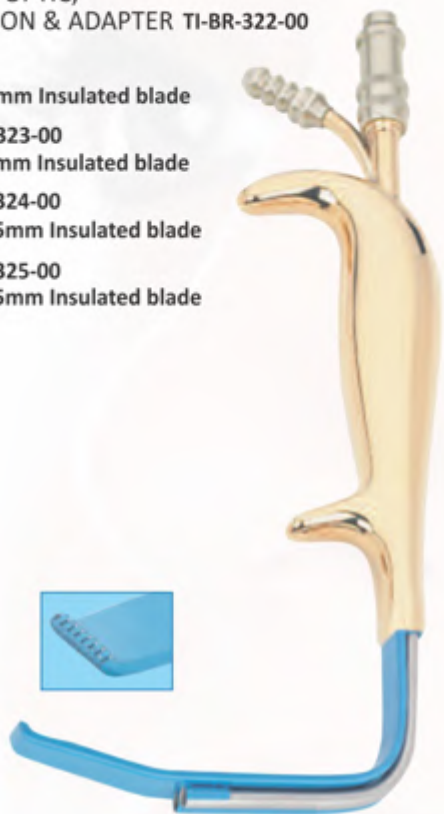

BLADE WITH TEETH, FIBER OPTIC,
SUCTION & ADAPTER TI-BR-326-00

- 80x16mm wide blade
- TI-BR-327-00
- 80x25mm wide blade
- TI-BR-328-00
- 90x25mm wide blade
- TI-BR-329-00
- 110x25mm wide blade
- TI-BR-330-00
- 130x16mm wide blade
- TI-BR-331-00
- 150x16mm wide blade

- TI-BR-332-00
- 150x25mm wide blade
- TI-BR-333-00
- 150x30mm wide blade
- TI-BR-334-00
- 150x36mm wide blade
- TI-BR-335-00
- 180x16mm wide blade
- TI-BR-336-00
- 180x25mm wide blade



BLADE WITH TEETH,
FIBER OPTIC, SUCTION &
ADAPTER TI-BR-337-00

180x16mm wide blade
insulated

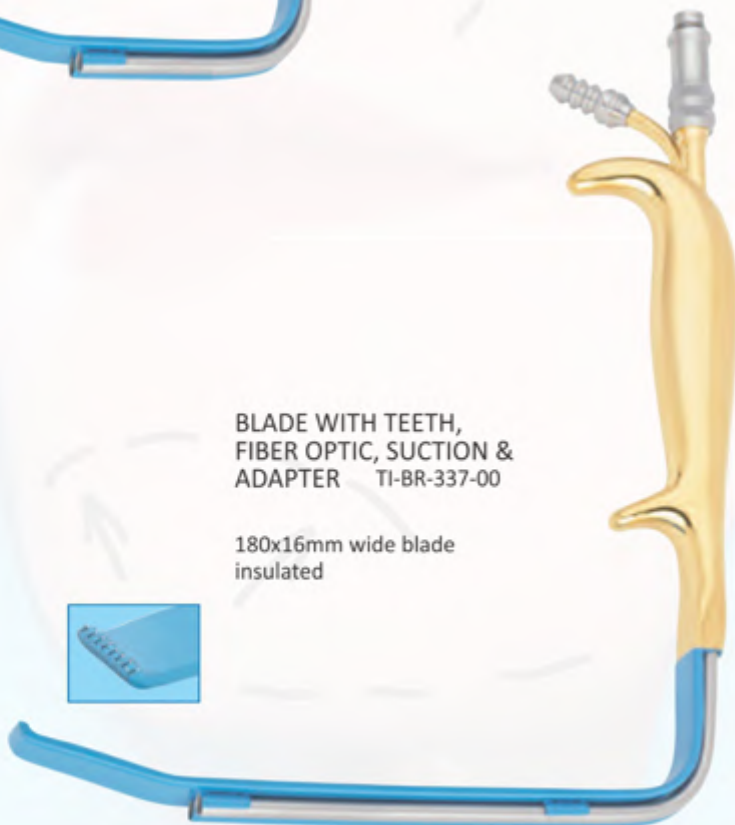

BREAST RETRACTORS

BLADE WITH TEETH
4MM DEEP,
FIBER OPTIC &
SUCTION TI-BR-338-00

120x16mm wide blade
TI-BR-339-00
180x16mm wide blade

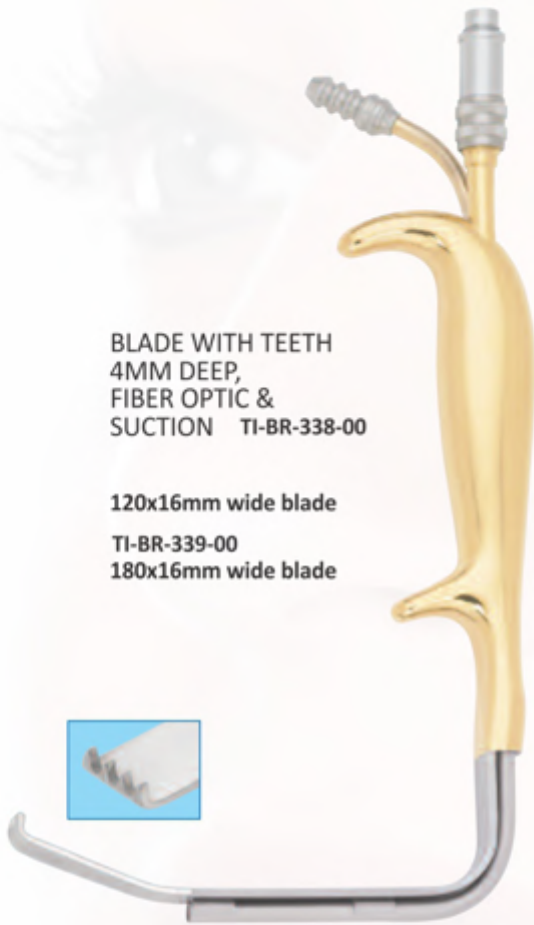

BLADE WITH TEETH,
FIBER OPTIC &
ADAPTER TI-BR-340-00

130x16mm wide blade
TI-BR-341-00
80x25mm wide blade
TI-BR-342-00
120x25mm wide blade
TI-BR-343-00
150x25mm wide blade



WITH FIBER OPTIC &
ADAPTER TI-BR-344-00

- 70x16mm wide blade
- TI-BR-345-00
- 90x22mm wide blade
- TI-BR-346-00
- 90x27mm wide blade



WITH SUCTION TI-BR-347-00

- 80x16mm wide blade
- TI-BR-348-00
- 90x27mm wide blade
- TI-BR-349-00
- 150x25mm wide blade
- TI-BR-350-00
- 180x25mm wide blade

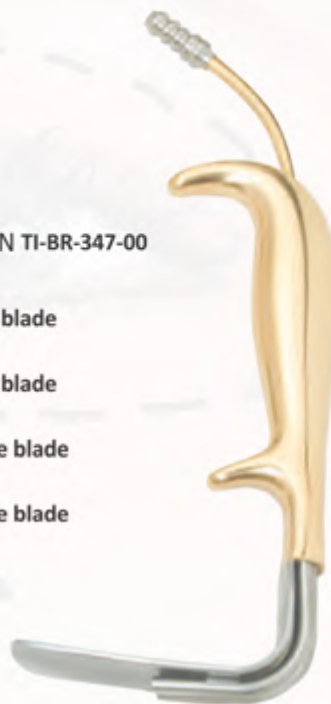

WITH FIBER OPTIC & ADAPTER TI-BR-351-00

- 130x16mm wide blade
- TI-BR-352-00
- 130x22mm wide blade
- TI-BR-353-00
- 150x16mm wide blade
- TI-BR-354-00
- 150x25mm wide blade

- TI-BR-355-00
- 150x36mm wide blade
- TI-BR-356-00
- 180x16mm wide blade
- TI-BR-357-00
- 180x25mm wide blade
- TI-BR-358-00
- 220x27mm wide blade
- TI-BR-359-00
- 190x25mm wide blade



WITH FIBER OPTIC &
ADAPTER INSULATED TI-BR-360-00

- 150x16mm wide blade



WITH SUCTION,
INSULATED TI-BR-361-00

150x25mm wide blade

TI-BR-362-00

180x25mm wide blade



120° & 130° ANGLES
WITH SUCTION,
INSULATED TI-BR-363-00

180x25mm wide blade

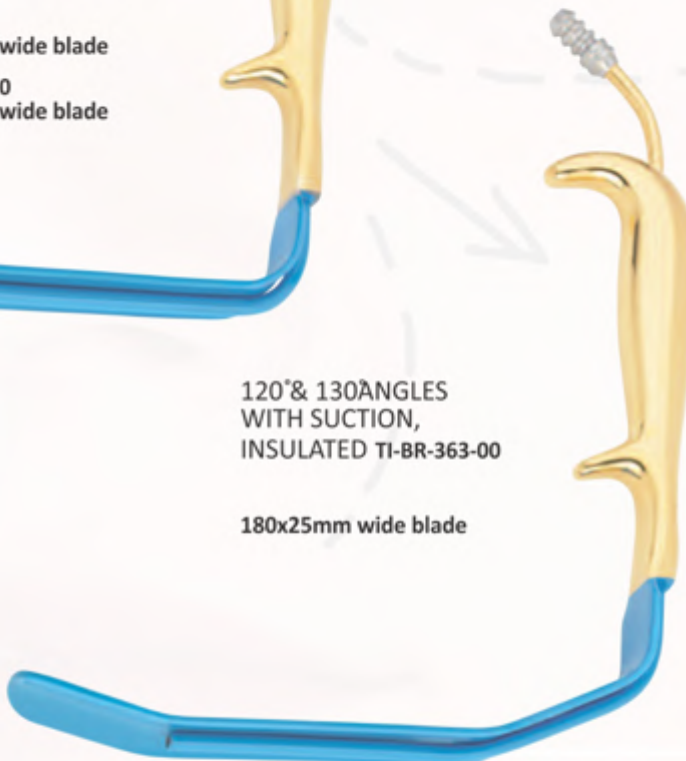

120° & 130° ANGLES WITH SUCTION TI-BR-364-00

180x16mm wide blade

TI-BR-365-00

180x25mm wide blade

TI-BR-366-00

180x27mm wide blade

TI-BR-367-00

180x30mm wide blade

TI-BR-368-00

350x30mm wide blade,
120° & 150° angles

TI-BR-369-00

350x30mm wide blade,
120° & 150° angles
without suction

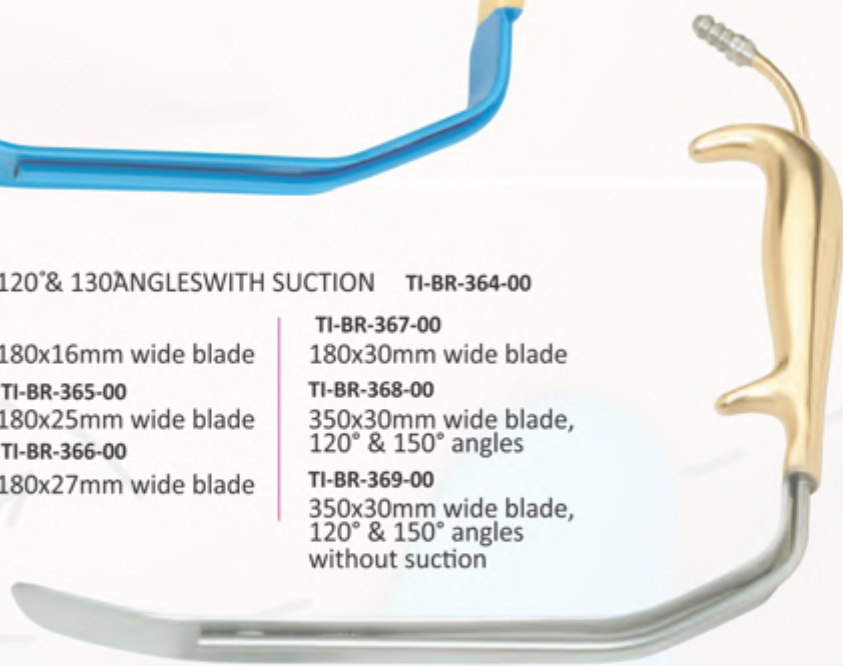



The Surgivalley Double Handle Breast Retractors are designed so both the surgeon and the assistant can grasp the retractor during Breast Augmentation Pocket Dissection, thus alleviating surgeon fatigue.

They are available in different blade lengths and widths, with and without teeth as well as with the suction tube in the standard position or

reversed 180° **TI-BR-370-00**
/reverse suction tube

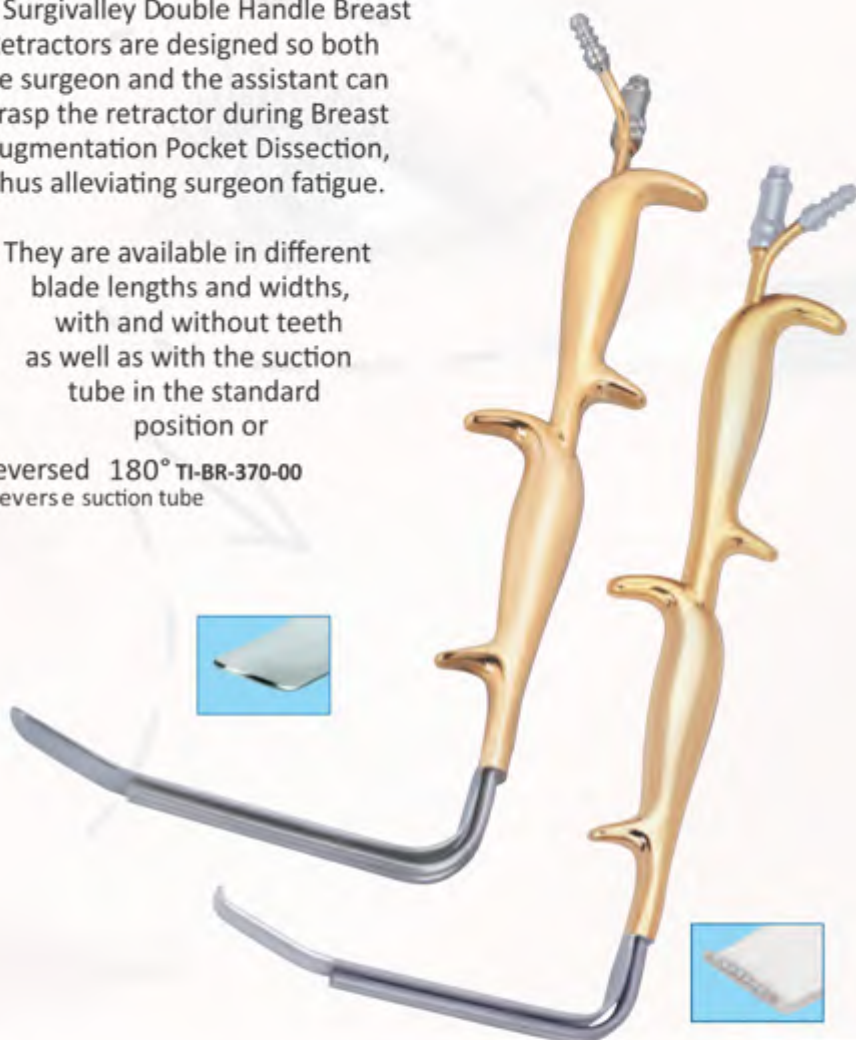

150x25mm, w/teeth,
w/fiber optic, suction & adapter
w/reverse suction tube

TI-BR-371-00

150x25mm, w/teeth,
w/fiber optic & adapter

TI-BR-372-00

80x25mm, w/teeth,
w/fiber optic, suction & adapter
w/reverse suction tube

TI-BR-373-00

80x25mm, w/teeth,
w/fiber optic, & adapter

TI-BR-374-00

180x25mm,
w/fiber optic, suction & adapter
w/reverse suction tube

TI-BR-375-00

150x16mm,
w/fiber optic, suction & adapter

TI-BR-376-00

180x16mm,
w/fiber optic, suction & adapter

TI-BR-377-00

150x25mm,
w/fiber optic, suction & adapter

TI-BR-378-00

80x16mm,
w/fiber optic, suction & adapter
w/reverse suction tube

TI-BR-379-00

150x16mm,
w/fiber optic, suction & adapter
w/reverse suction tube

TI-BR-380-00

180x16mm,
w/fiber optic, suction & adapter
w/reverse suction tube

TI-BR-381-00

180x16mm,
w/fiber optic, suction & adapter
w/teeth

TI-BR-382-00

180x30mm,
w/fiber optic, suction & adapter

Breast Retractor With Double Handle

BREAST REDUCTION COMPRESSION DEVICE



The proven compression device that facilitates breast reduction surgery.

How to use:

1. Wrap the Breast Reduction Compression Device around the base of the breast and put the band into a loop.
2. Tighten the breast by contracting the band.
3. Release the Breast Reduction Compression Device by pulling back the small plastic tab at the head.
4. Autoclavable, limited reusability. TI-BR-383-00



Standard size for an approximate
500-800 gram reduction.
5 pcs. per set

ASSI.BRC5XL
Extra large size for an approximate
1300 gram reduction.
5 pcs. per set



*Elevated breast pocket with
implant in place*

Circular Breast Retractor

allows a very conservative sized incision for the introduction of the implant or removal/replacement of the implant.

- Designed to create an Optical Cavity in the Breast Pocket through a small incision
- Facilitates visualization for better hemostasis in the Breast Pocket
- Provides better visualization for dissection of the periphery of the Breast Pocket

TI-BR-384-00
COUNTERCLOCKWISE
BLADE WITHOUT
FIBER OPTIC OR SUCTION

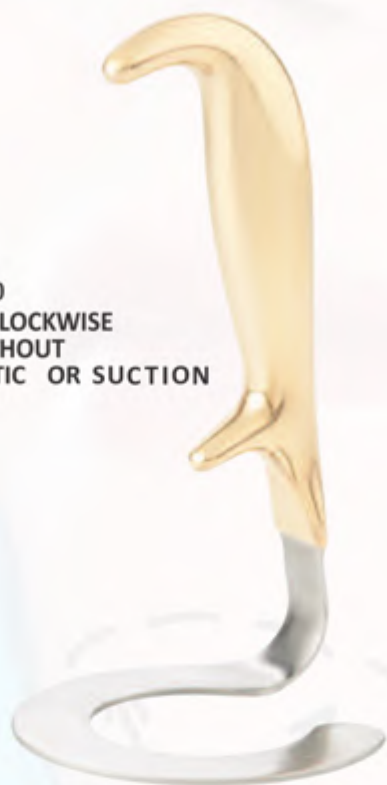

TI-BR-385-00
With 2" extended arm



WITHOUT FIBER OPTIC
OR SUCTION **TI-BR-386-00**

WITH FIBER OPTIC **TI-BR-387-00**

THE STANGER CIRCULAR BREAST RETRACTOR

WITH SUCTION TI-BR-388-00

TI-BR-389-00
2cm wide blade with
suction tube recessed in blade

TI-BR-390-00
With 2" extended arm
ITH SUCTION

AND SUCTION TI-BR-392-00

With 4" extended arm,
fiber optic, suction &
adapter

2" arm with
recessed suction tube
TI-BR-393-00



*Recessed suction tube
bottom view*

WITH FIBER OPTIC
AND SUCTION
TI-BR-394-00 ITH FIBER OPTIC

WITH ENDOSCOPIC
SCOPE SHEATH **TI-BR-395-00**

180x16mm wide blade
with 4mm endoscopic scope sheath,
rotatable single stop-cock

TI-BR-396-00

180x25mm wide blade
with 4mm endoscopic scope sheath,
rotatable single stop-cock

TI-BR-397-00

180x25mm wide blade
with 5mm endoscopic scope sheath,
rotatable single stop-cock WITH ENDOSCOPIC

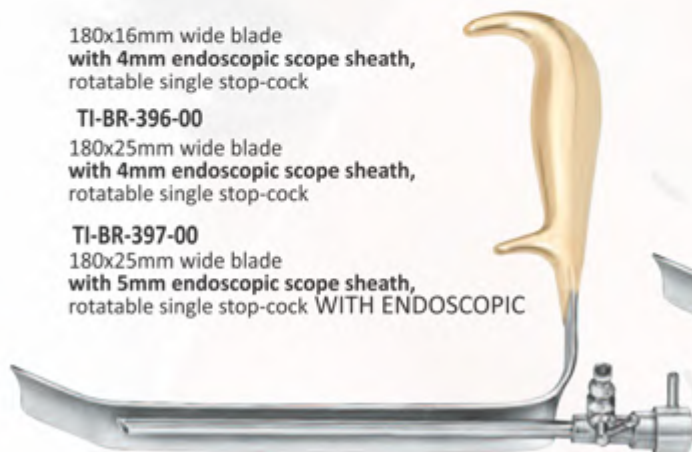

SCOPE SHEATH

TI-BR-398-00

180x25mm wide blade
with 10mm endoscopic scope sheath,
rotatable single stop-cock



SCOPE SHEATH WITH
UNIVERSAL LOCKING
MECHANISM **TI-BR-400-00**

180 x 25mm wide blade
with 10 mm endoscopic scope sheath,
with universal locking mechanism screw

WITH ENDOSCOPIC
SCOPE SHEATH

TI-BR-399-00

190x22mm wide blade
with 4mm endoscopic scope sheath,
rotatable single stop-cock, 35° angle
WITH ENDOSCOPIC

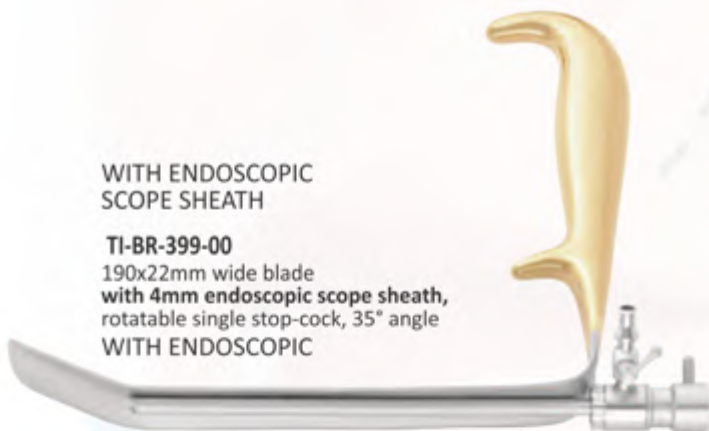

SCOPE SHEATH **TI-BR-401-00**

180x16mm wide blade
without endoscopic scope sheath

TI-BR-402-00

180x25mm wide blade
without endoscopic scope sheath

TI-BR-403-00

210x27mm wide blade
without endoscopic scope sheath

TI-BR-404-00

350x25mm wide blade
without endoscopic scope sheath

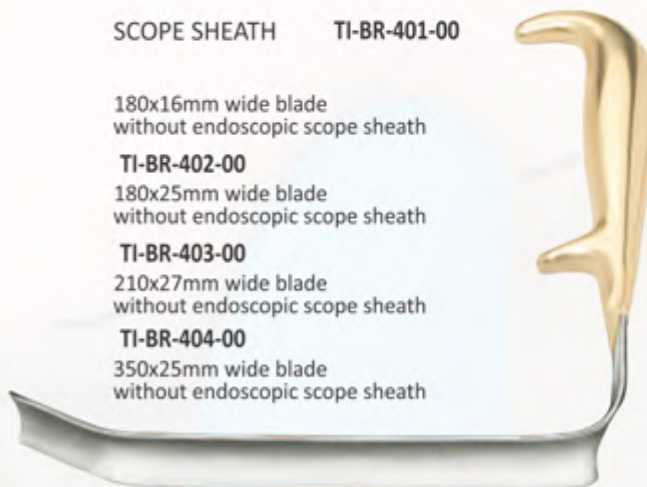

BREAST RETRACTORS

MAMMARY RETRACTOR
WITH ENDOSCOPIC
SCOPE SHEATH **TI-BR-405-00**

*for 10mm scope with suction
and compression screw
1in. x 4³/₄in. Blade*



MAMMARY RETRACTOR
WITH ENDOSCOPIC
SCOPE SHEATH **TI-BR-406-00**

*for 10mm scope with suction
1 in. x 10 in. Blade*



WITH SUCTION **TI-BR-407-13**

13cm, 3cm blade,
4mm suction tube, 12 FR

TI-BR-408-13

13cm, 4cm blade,
4mm suction tube, 12 FR

TI-BR-409-13

13cm, 4cm blade with teeth
at 90° angle,
4mm suction tube, 12 FR

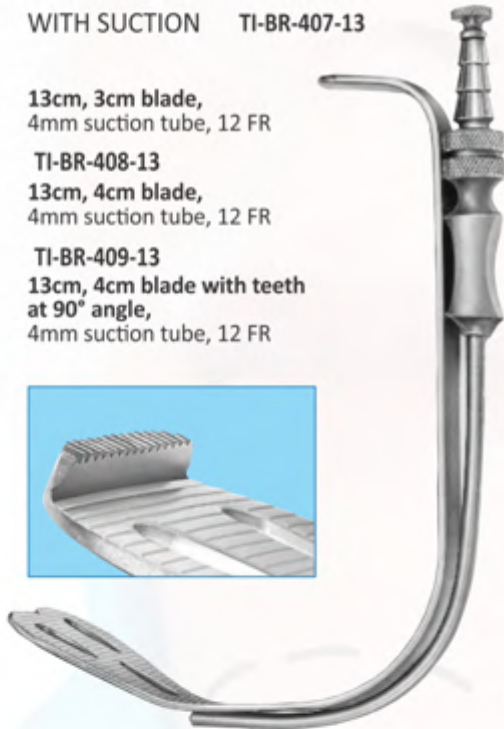
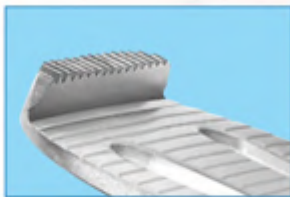

WITH FIBER OPTIC &
ADAPTER **TI-BR-410-13**

13cm, 3cm wide blade

TI-BR-411-13

13cm, 4cm wide blade



HEANEY RETRACTOR
WITH FIBER OPTIC &
ADAPTER **TI-BR-411-27**

27cm, 45x25mm blade



HARRINGTON RETRACTOR
WITH SUCTION & FIBER OPTIC TI-BR-412-320

40x320mm

TI-BR-413-320
40x320mm, insulated



TI-BR-414-00

BREAST RETRACTORS



**DOUBLE ENDED
RETRACTOR TI-BR-415-23**

23cm, serrated
Curved blade 60mm x 20mm
Straight blade 70mm x 34mm

TI-BR-416-23
23cm, serrated
Curved blade 60mm x 20mm
Straight blade 100mm x 34mm



**FREEMAN FLAP
RETRACTOR**

TI-BR-417-205
20.5cm, 12mm wide



"SWEET HEART" RETRACTOR

TI-BR-419-15
15cm, 4cm wide serrated blade



**FREEMAN FLAP
RETRACTOR**

TI-BR-418-205
20.5cm, 25mm wide



BIGGS MAMMARY RETRACTORS
Narrow Blade

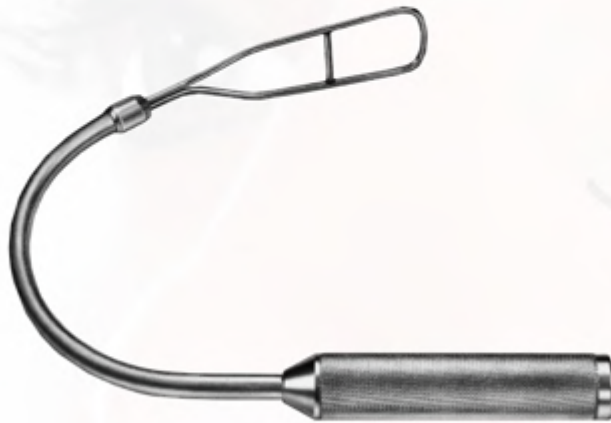

TI-BR-420-00
31mm wide

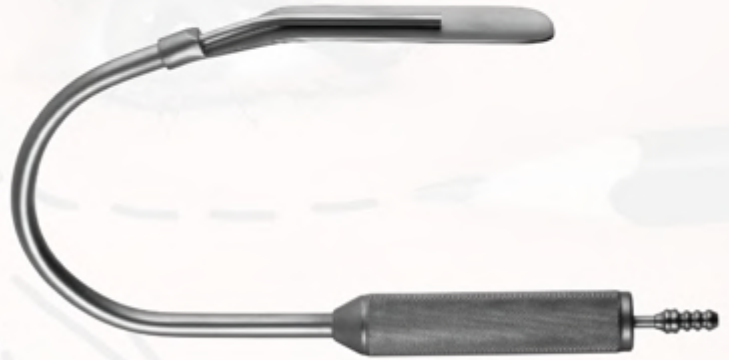

TI-BR-421-00
Solid blade and suction, 31mm wide

Standard Blade



TI-BR-422-00
5" long, 50mm wide

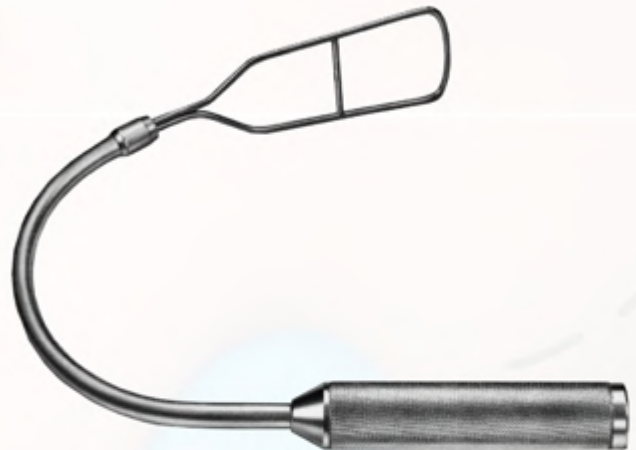

TI-BR-423-00
50mm wide

BIGGS MAMMARY RETRACTORS

Fiber Optic with universal adapter

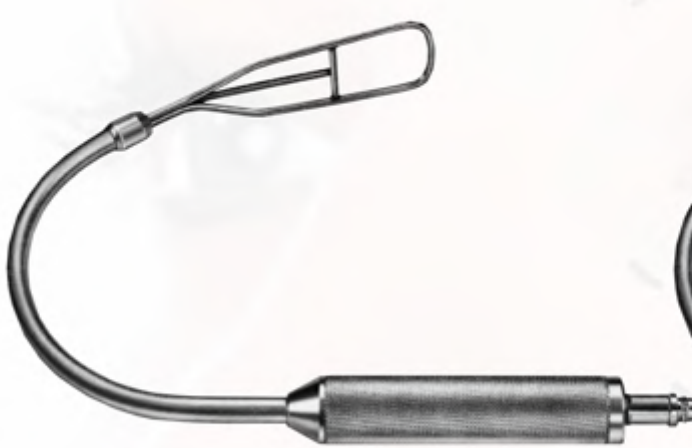

TI-BR-424-31
Narrow blade, 31mm wide

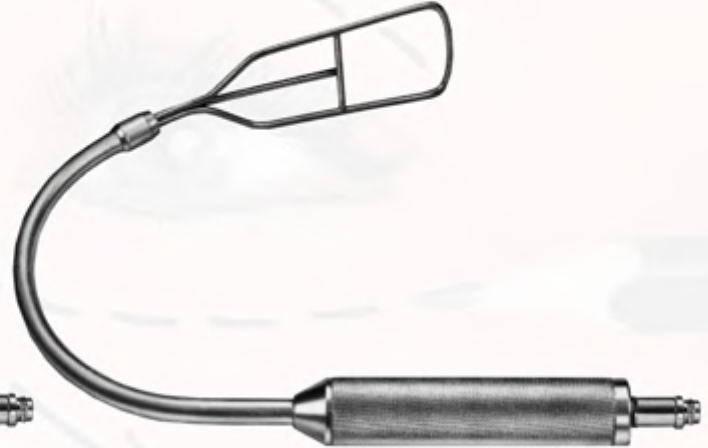

TI-BR-425-50
Standard blade, 50mm wide

Fiber Optic with Suction and universal adapter

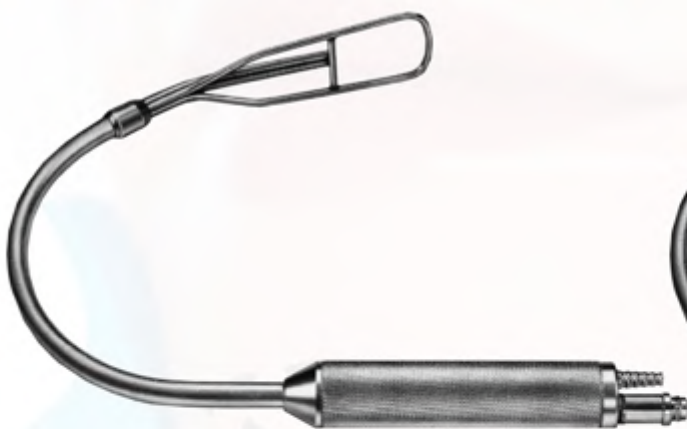

TI-BR-426-31
Narrow blade, 31mm wide

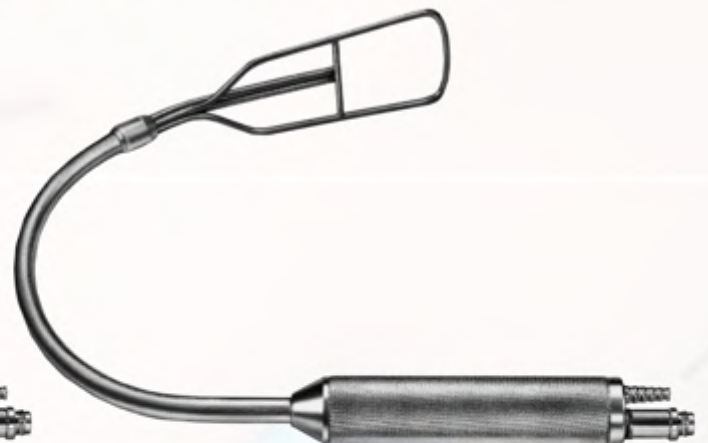

TI-BR-427-50
Standard blade, 50mm wide

A Multipurpose Retractor the Miller Wave Retractor aims the

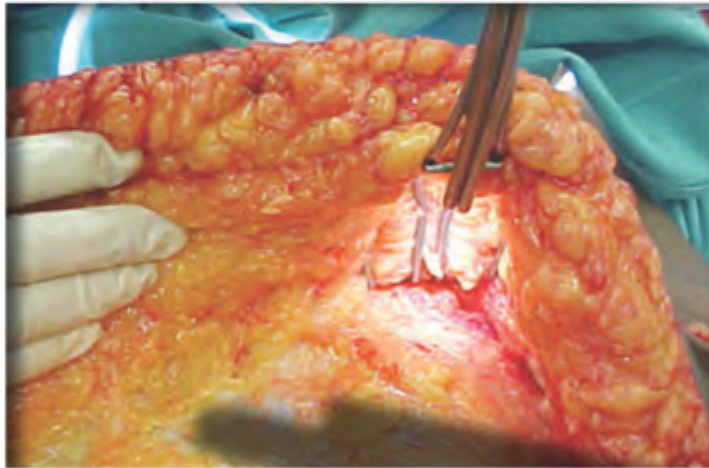

light directly at the point of dissection, elevates the tissue to permit the surgeon to visualize the interface of the tissue to be dissected apart, and to observe any bleeding point that may arise.

TI-BR-428-00

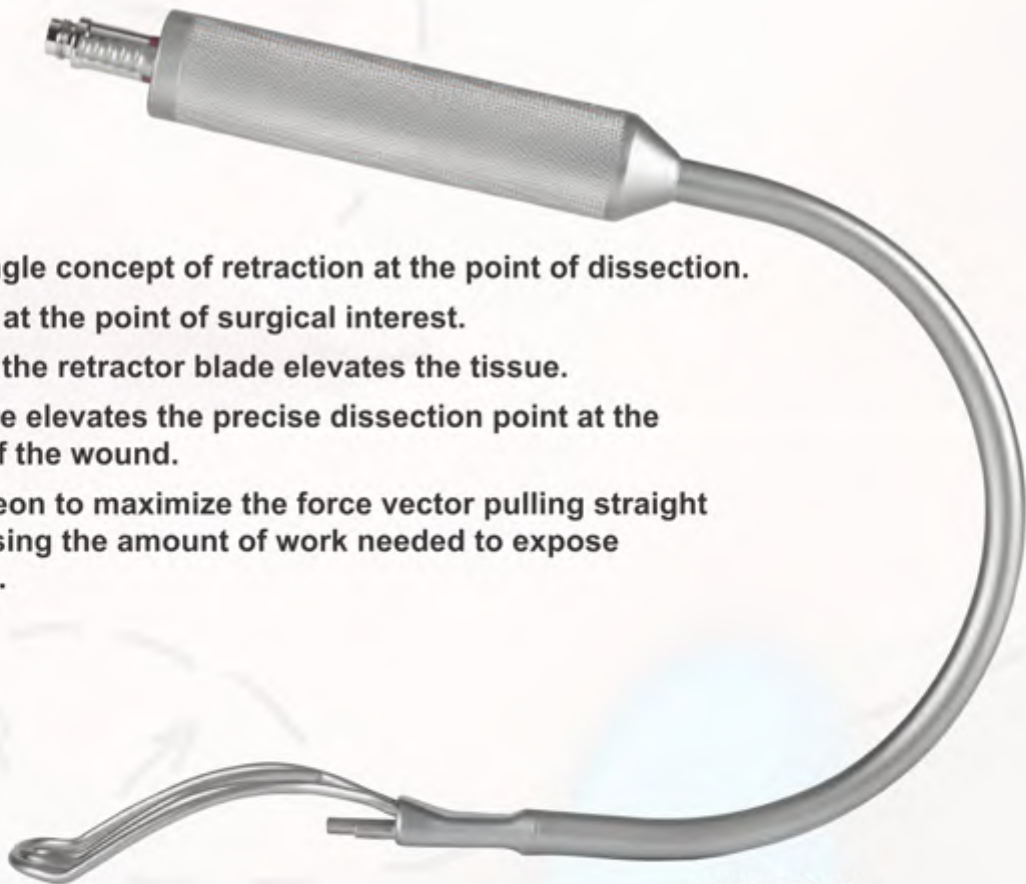

- Employs the single concept of retraction at the point of dissection.
- Directs the light at the point of surgical interest.
- The 1st Wave in the retractor blade elevates the tissue.
- Unique 2nd Wave elevates the precise dissection point at the furthest depth of the wound.
- Allows the surgeon to maximize the force vector pulling straight up, thus decreasing the amount of work needed to expose the surgical site.

TI-BR-429-50
50MM wide blade with
Fiber Optic and Suction

GYNECOMASTIA RETRACTOR

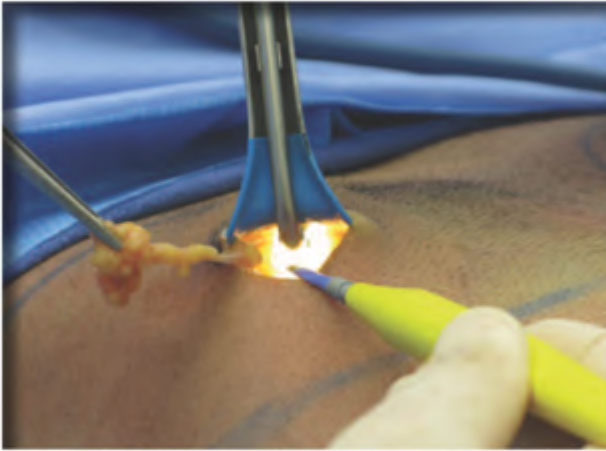

Designed by:
Robert Caridi MD, FACS
Diplomat, American Board of Plastic Surgery
Austin, Texas **TI-BR-431-00**



TI-BR-430-00
Insulated blade
with Fiber Optic

- *Permits a small Periareolar Incision with its narrow neck and a wider blade,*
- *the surgeon can easily work to contour the chest tissue.*

- *Eliminates the need for multiple retractors.*



HARRINGTON RETRACTOR
WITH FIBER OPTIC ILLUMINATION & IRRIGATION
TI-BR-432-00



RING BREAST RETRACTOR
WITH FIBER OPTIC ILLUMINATION & IRRIGATION
TI-BR-432C-00

BREAST RETRACTORS

Tebbetts Fibre Optic Breast Retractor

With fibre optic illumination and suction

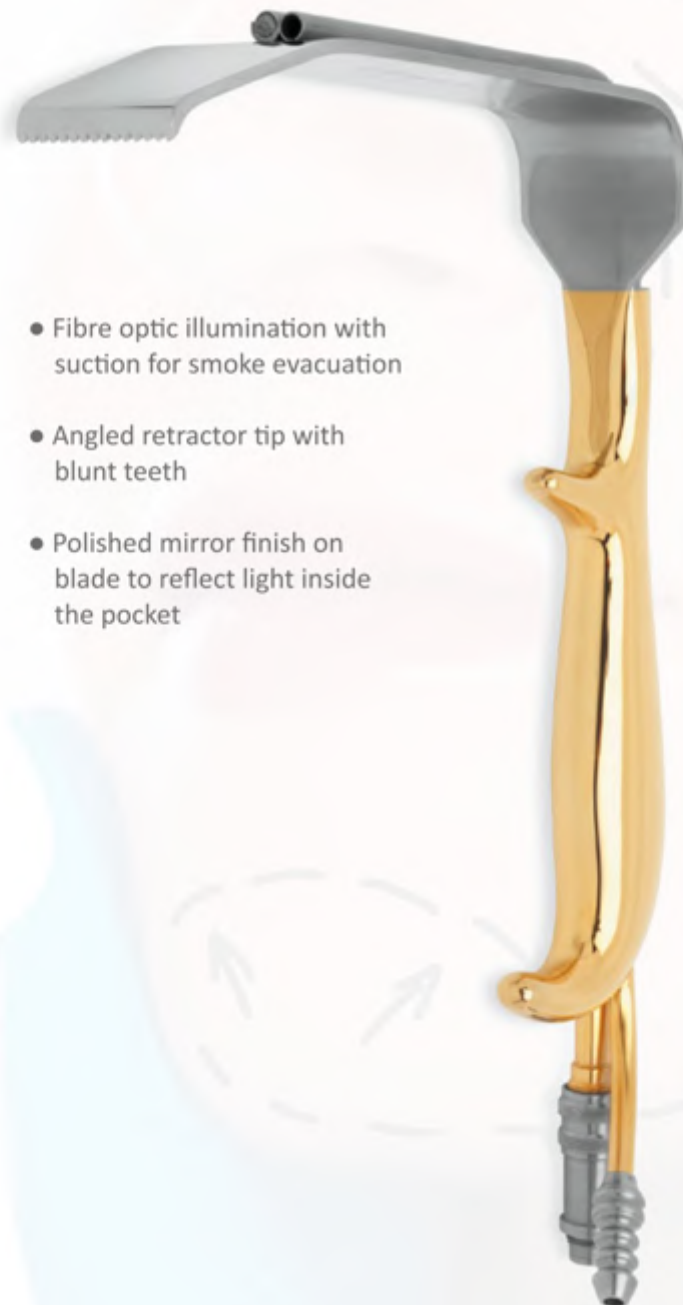
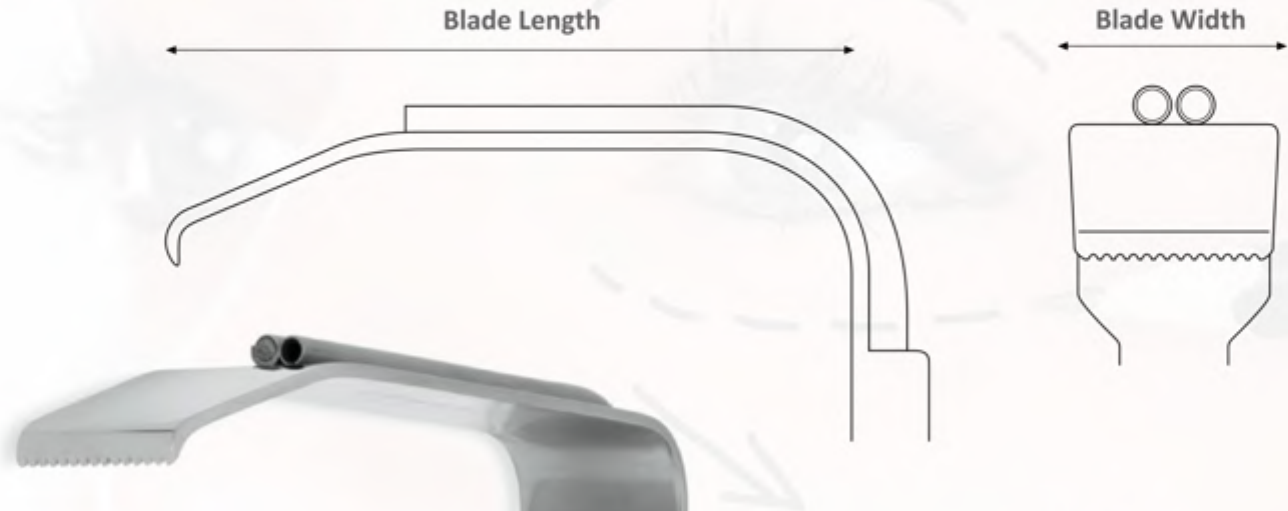

- Fibre optic illumination with suction for smoke evacuation
- Angled retractor tip with blunt teeth
- Polished mirror finish on blade to reflect light inside the pocket

With Teeth

Code	Length	Width
TI-BR-434-9024	90mm	24mm
TI-BR-435-9030	90mm	30mm
TI-BR-436-1536	150mm	36mm
TI-BR-437-1936	190mm	36mm



Blunt

Code	Length	Width
TI-BR-438-9024	90mm	24mm
TI-BR-439-9030	90mm	30mm
TI-BR-440-1536	150mm	36mm
TI-BR-441-1936	190mm	36mm

TEBBETTS SPATULA WITH HOLE

TI-DI-442-00



TEBBETTS SPATULA DISSECTOR

TI-DI-443-00



TEBBETTS ANGUATED DISSECTOR

TI-DI-444-00



SOLZ RETRACTOR

TI-DI-445-00



DEAVERS RETRACTOR

- TI-DI-446-00 ½" x 6" SV-2018-318 1½" x 12"
- TI-DI-447-00 ¾" x 8" SV-2018-319 2" x 12"
- TI-DI-448-00 1" x 12" SV-2018-320 2½" x 12"



- TI-DI-449-00 Adult 1½" x 12"
- TI-DI-450-00 1" x 12"
- TI-DI-451-00 1" x 16"



DEAVERS RETRACTOR WITH FIBER OPTIC LIGHT CARRIERS

BREAST DISSECTORS



Spatulated Blade TI-BD-452-22

Non-Insulated, 33cm overall length, 22cm working length

TI-BD-453-30

Non-Insulated, 42cm overall length, 30cm working length insulated **Spatulated Blade ASSI.AB13526**



Malleable Shaft, Non-Insulated, 33cm overall length, 22cm working length

TI-BD-454-22

Malleable Shaft, Non-Insulated, 42cm overall length, 30cm working length

TI-BD-455-30



Insulated, 33cm overall length, 22cm working length

TI-BD-456-22

Insulated, 42cm overall length, 30cm working length malleable **Spatulated Blade**

TI-BD-457-30



Oval Spatulated Blade TI-BD-458-22

Non-Insulated, 33cm overall length, 22cm working length

TI-BD-459-30

Non-Insulated, 42cm overall length, 30cm working length



Oval Half Serrated Blade TI-BD-460-215

Non-Insulated, 21.5cm overall length



TI-BD-460-215



Non-Insulated, 33cm overall length, 22cm working length
TI-BD-461-33

Non-Insulated, 42cm overall length, 30cm working length
TI-BD-462-30

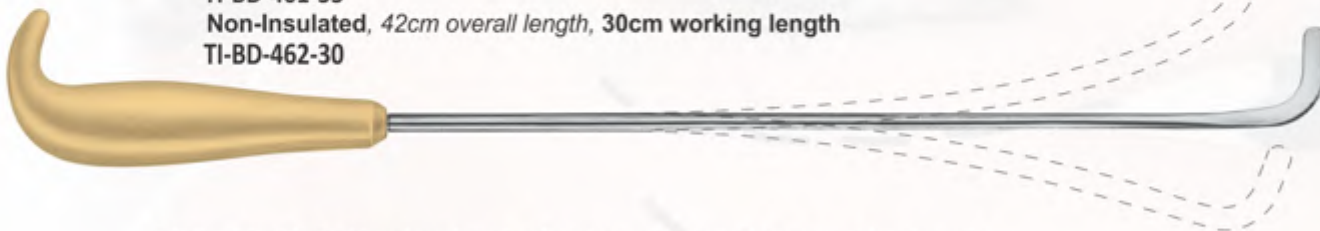

Malleable Shaft, Non-Insulated, 33cm overall length, 22cm working length
TI-BD-463-33

Malleable Shaft, Non-Insulated, 42cm overall length, 30cm working length
TI-BD-464-42

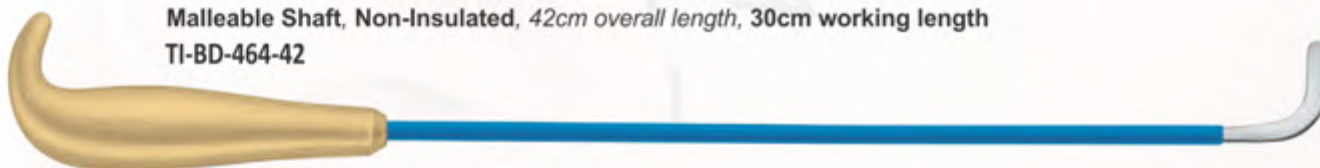

Insulated Angulated Blade TI-BD-465-00

Insulated, 33cm overall length, 22cm working length

TI-BD-466-33

Insulated, 42cm overall length, 30cm working length

Malleable Angulated Blade TI-BD-467-42



Curved, Blunt Blade TI-BD-468-00

Non-Insulated, 30cm overall length, 18cm working length
TI-BD-469-30

Non-Insulated, 33cm overall length, 21cm working length
TI-BD-470-21

Non-Insulated, 36cm overall length, 25cm working length

Blunt Dissector Double Ended



TI-BD-471-00 11mm & 12mm

TI-BD-472-00 12mm & 13mm **Angulated Blade TI-BD-473-00**

BREAST DISSECTORS



Non-Insulated, 41cm overall length, 30cm working length
TI-BD-474-41



Non-Insulated, small spatula working end for 1.5mm or less incision, 27cm working length
TI-BD-475-27



Transaxillary, Fenestrated Blade TI-BD-476-00

Non-Insulated, 40cm overall length, 28cm working length Jakobs Small Spatulated Blade TI-BD-477-40

Biggs Mammoplasty Retractor
with suction & fiber light carrier



TI-BR-478-40

MARX BREAST RETRACTOR



TI-BR-479-40

Agris Dingman Transauxillary
Breast Dissector Pair Left / Right



TI-DI-480-40

Mac Collum Dingman Transauxillary
Breast Dissector Angled Shaft



TI-DI-481-40

BREAST DISSECTORS/RETRACTORS



TI-DI-482-36

36cm, set of 2 (Left and Right) for submammary dissection, with knurled handle



TI-DI-483-32

Spatulated, semi-malleable blade, 25mm x 185mm, 32cm overall length

TI-DI-484-32

Spatulated, semi-malleable blade, 38mm x 190mm, 32cm overall length





LIPOSUCTION

- TI-LS-485-03 3ml
- TI-LS-486-05 5ml
- TI-LS-487-10 10ml
- TI-LS-488-20 20ml
- TI-LS-489-50 50ml



Transfer Adapter

TI-LS-490-00

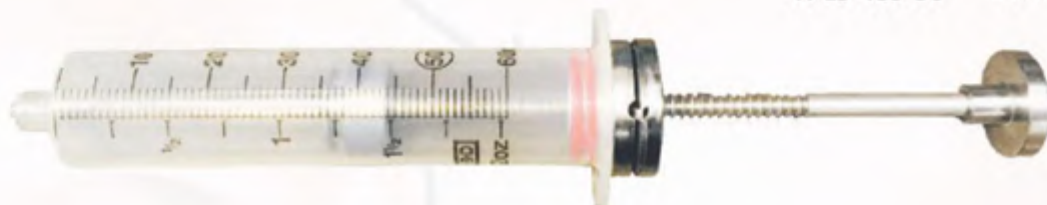

Injection Gun

TI-LS-492-00

Use with 5ml, 10ml and 20ml

TI-LS-491-05



Cannula Handle

TI-LS-493-00



Adapter

TI-LS-494-00



Luer Lock Stopper

for cannula
TI-LS-495-00

LIPOSUCTION



MERCEDES with 2 PORTS

This circumferential two port configuration cell friendly liposuction cannula is effective for multi-plane soft tissue harvesting

TI-LS-496-03 3mmx32cm



MERCEDES with 3 PORTS

This circumferential three port configuration cell friendly liposuction cannula is effective for multi-plane soft tissue harvesting

TI-LS-497-02 2mmx18cm
 TI-LS-498-03 3mmx18cm
 TI-LS-499-04 4mmx18cm
 TI-LS-500-03 3mmx30cm
 TI-LS-501-04 4mmx30cm
 TI-LS-502-02 2mmx32cm
 TI-LS-503-05 5mmx32cm



PYRAMID

This commonly used design has three ports located 180 degrees from the thumb print. It is a slightly more aggressive cannula than the Standard during liposuction procedures

TI-LS-504-02 2mmx20cm
 TI-LS-505-03 3mmx20cm
 TI-LS-506-04 4mmx20cm
 TI-LS-507-04 4mmx32cm
 TI-LS-508-05 5mmx32cm



STANDARD

This is the most common cell friendly cannula design for soft tissue removal. The single port is located 180 degrees from the thumb rest on the hub

TI-LS-509-24 2.4mmx20cm
 TI-LS-510-03 3.0mmx20cm
 TI-LS-511-37 3.7mmx20cm
 TI-LS-512-04 4mmx32cm
 TI-LS-513-05 5mmx32cm
 TI-LS-514-03 3mmx32cm

FLAP

The Flap is primarily used as an undermining dissector, and in smaller diameters, for facial tissue removal. The Flap Cannula in a 2.1mm diameter is very useful for undermining the nasolabial fold prior to autologous tissue injections, as well as for tissue removal

TI-LS-515-21 2.1mm x 9cm
 TI-LS-516-24 2.4mmx20cm
 TI-LS-517-03 3.0mmx20cm
 TI-LS-518-03 3.0mmx30cm
 TI-LS-519-04 4.0mmx30cm



V-DISSECTOR

This cannula is specifically designed for use in the superficial compartment of the truncal area. The cutting notch is very useful for undermining in facial procedures and in dense, fibrous tissue in this anatomic area



TI-LS-520-16	1.6mmx8.5cm
TI-LS-521-24	2.4mmx18cm

BASKET CANNULA

It can operate as an equalizer without vacuum to treat adipose tissue and skin irregularities in revision liposuction and fat transfer procedures.

The Basket Cannula is also adept under vacuum as a fat harvesting cannula. For finishing, this cannula can be used as an injector for equalizing and adding adipose tissue to sculpt smoother contours



TI-LS-522-03	3mmx30cm
TI-LS-523-04	4mmx30cm

CANNULA & SYRINGES FOR INFILTRATION



TI-LS-524-25	2.5mm
TI-LS-525-35	3.5mm

Tonnard injector



TI-LS-526-02	2mmx9cm
TI-LS-527-25	2.5mmx9cm
TI-LS-528-03	3mmx9cm

SMALL OVAL INJECTOR



TI-LS-529-07	0.7mmx7cm
TI-LS-530-09	0.9mmx7cm
TI-LS-531-12	1.2mmx7cm
TI-LS-532-16	1.6mmx9cm
TI-LS-533-21	2.1mmx9cm
TI-LS-534-27	2.7mmx9cm
TI-LS-535-21	2.1mmx12cm
TI-LS-536-21	2.1mmx17cm
TI-LS-537-24	2.4mmx17cm

ARVESTER CANNULA

with 3 holes FIX HANDLE
Length 32mm



RETRACTORS



SALDANHA -SOLZ RETRACTOR

ABDOMINAL RETRACTOR FOR LIPOABDOMINPLASTY

TI-BR-538-00



**RETRACTOR WITH CHANNEL FOR
ENDOSCOPE**

TI-BR-539-00

Cottle Cartilage Crusher/Morselizer

Useful for reforming soft tissue. Available in smooth and serrated 15 mm x 60 mm surface.

- TI-LS-540-15 Smooth
- TI-LS-541-00 Longitudinal Serrations



Jost Cartilage Crusher/Morselizer

Multi-surfaces are interchangeable to allow for a variety of possible results. The three surfaces are smooth, longitudinal and cross serrated.

- TI-LS-542-00 50 mm x 30 mm Surface



Ragnell-Davies Retractor

- 14cm/5½" length

TI-RE-543-14



Langenbeck Retractor

- 21.5cm/8½" length



Code	Blade Size		
	Depth	Width	
TI-RE-544-215	22mm	6mm	Small
TI-RE-545-215	45mm	13mm	Medium
TI-RE-546-215	65mm	25mm	Large

MICRO MONOPOLAR FORCEPS

Insulated, hand-activated with non-stick coated straight, smooth jaws.

Surgivalley Micro Monopolar Forceps are specifically constructed to reach the entire length of the pocket, and as such are ideal for inframammary and initial, upper axillary pocket dissections. The forceps precisely combine cut and coagulation current for best possible dissection, while averting unnecessary current spread, tissue damage and bleeding. **Limited reuse.**

TI-EL-547-15
15cm, 6 in., 0.7mm tip dia.
bayonet

TI-EL-548-19
19cm, 7 1/2 in., 0.7mm tip dia.
bayonet

TI-EL-549-24
24cm, 9 1/2 in., 0.7mm tip dia.
bayonet

TI-EL-550-24
24cm, 9 1/2 in., 0.7mm tip dia.
straight

TI-EL-551-26
26cm, 10 1/4 in., 0.7mm tip dia.
straight

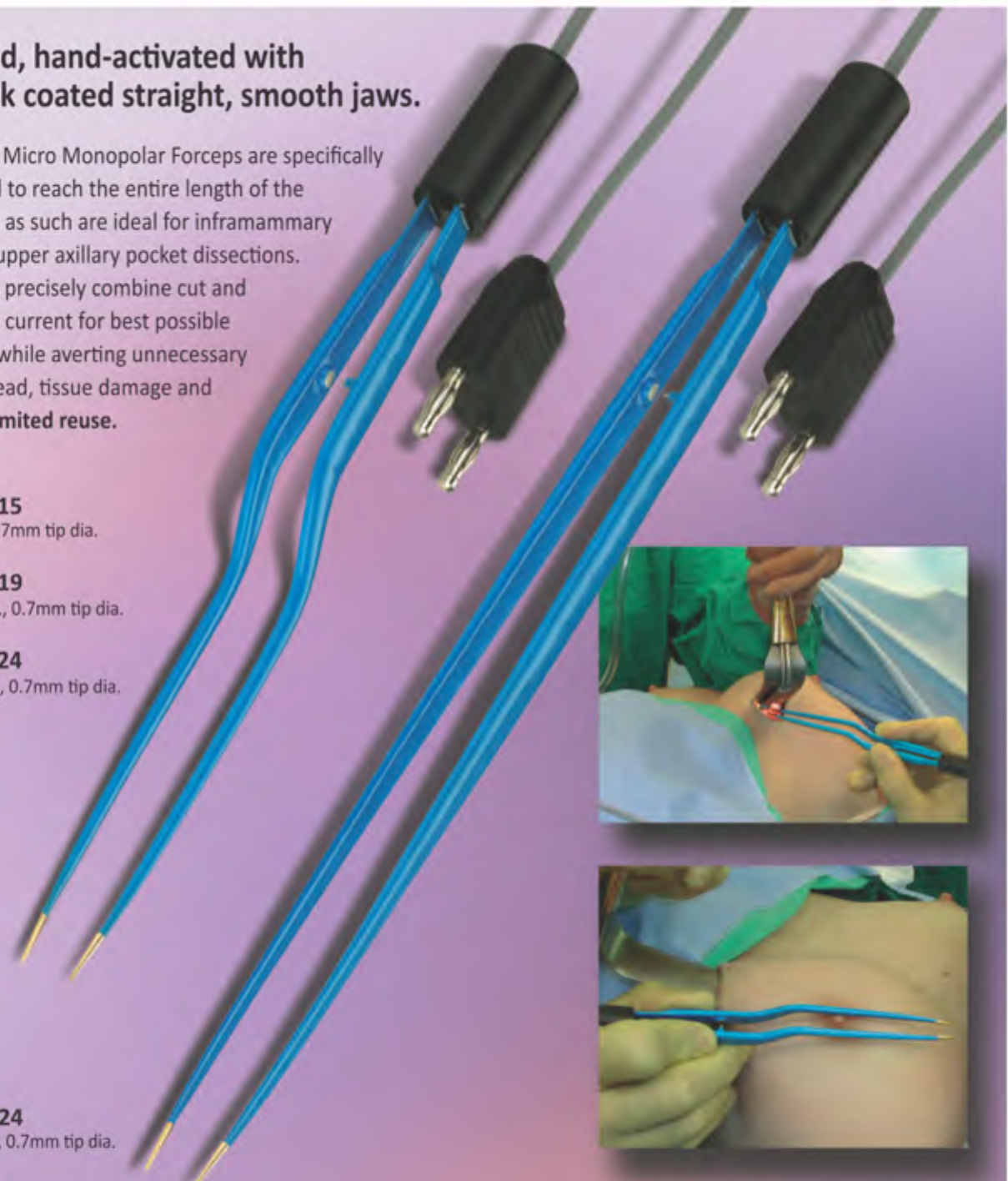

Insulated, hand-activated with Non-Stick straight, smooth jaws.

Eliminates "hotpots" and prevents tissue buildup on the forceps

in Lower Temperature Settings: No Charring and Minimizes Scarring.

The Metal Non-Stick jaw is Permanent made from the Metal.

Not just a coating or highly polished surface.

The tips do not continuously have to be removed from the operative site to be cleaned.

Surgivalley Micro Monopolar Forceps are specifically designed to reach

the entire length of the pocket.

Ideal for Inframammary and Initial, Upper Axillary Pocket Dissections.

The forceps precisely combine cut and coagulation

current for best possible dissection

preventing current spread, tissue

damage and bleeding.

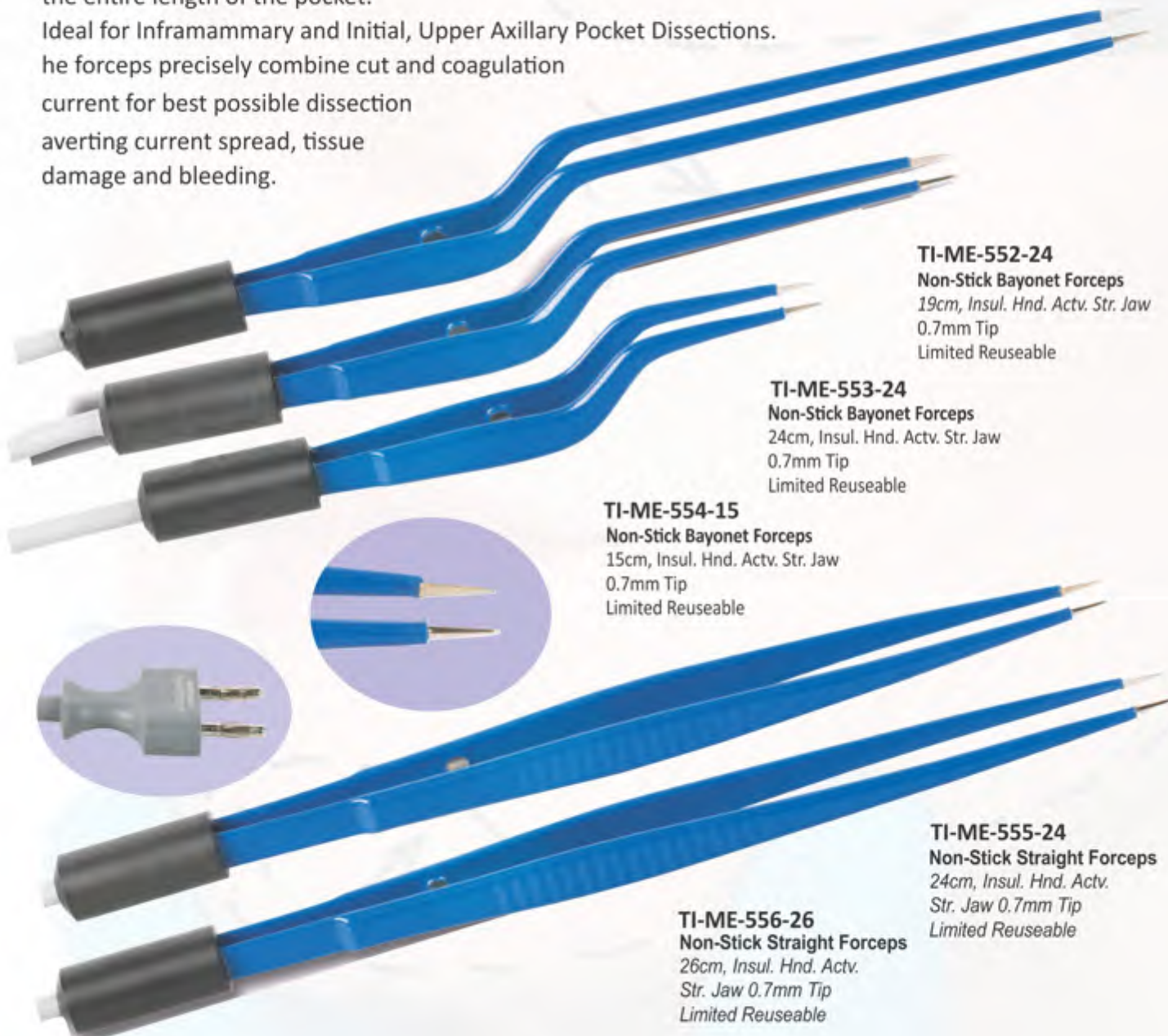

TI-ME-552-24
Non-Stick Bayonet Forceps
19cm, Insul. Hnd. Actv. Str. Jaw
0.7mm Tip
Limited Reuseable

TI-ME-553-24
Non-Stick Bayonet Forceps
24cm, Insul. Hnd. Actv. Str. Jaw
0.7mm Tip
Limited Reuseable

TI-ME-554-15
Non-Stick Bayonet Forceps
15cm, Insul. Hnd. Actv. Str. Jaw
0.7mm Tip
Limited Reuseable

TI-ME-555-24
Non-Stick Straight Forceps
24cm, Insul. Hnd. Actv.
Str. Jaw 0.7mm Tip
Limited Reuseable

TI-ME-556-26
Non-Stick Straight Forceps
26cm, Insul. Hnd. Actv.
Str. Jaw 0.7mm Tip
Limited Reuseable

BIPOLAR SCISSORS

Surgivalley Bipolar Scissors enable cutting and dissection with simultaneous bipolar coagulation. They can also be used for precise pinpoint or zone coagulation of blood vessels and tissue. The various working lengths allow the scissors to be used for a large number of applications in open surgery.

A patented design developed by Dr. J. Manushakian, ensures that the scissors are easy to use. The electrical current passes from one scissor blade to the other via the scissor screw (see fig 1 and 2). The power cable only needs to be attached to one ring, significantly reducing interference during a procedure.

SuperCut Scissors

TI-ES-557-18

Bipolar SuperCut Scissors, 18cm curved blades, round plug

TI-ES-558-21

Bipolar SuperCut Scissors, 21cm curved blades, round plug

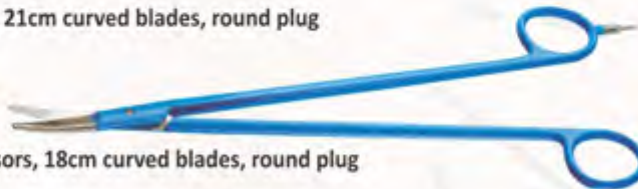
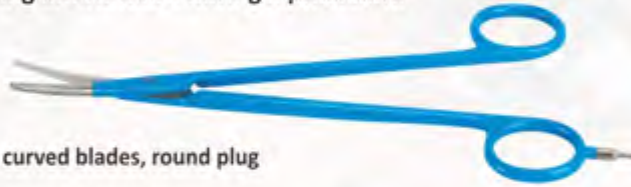

Easy handling

The power is supplied by means of a plug-in connection to only one ring of the handle. This simplifies handling during a procedure.

Standard Model

TI-ES-559-18

Bipolar Metzenbaum Scissors, 18cm curved blades, round plug

TI-ES-560-21

Bipolar Metzenbaum Scissors, 21cm curved blades, round plug

TI-ES-561-23

Bipolar Metzenbaum Scissors, 23cm curved blades, round plug

TI-ES-562-28

Bipolar Metzenbaum Scissors, 28cm curved blades, round plug

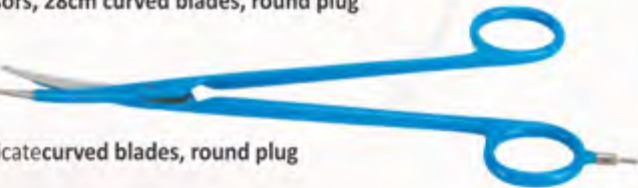

Delicate Model

TI-ES-563-18

Bipolar Scissors, 18cm delicate curved blades, round plug

TI-ES-564-21

Bipolar Scissors, 21cm delicate curved blades, round plug

TI-ES-565-23

Bipolar Scissors, 23cm delicate curved blades, round plug

TI-BS-566-28

Bipolar Scissors, 28cm delicate curved blades, round plug



Micro Model

TI-ES-567-13

Micro Bipolar Scissors, 13cm curved slim thin blades, round plug

TI-ES-568-14

Micro Bipolar Scissors, 14cm curved slim thin blades, round plug

TI-ES-569-17

Micro Bipolar Scissors, 17cm curved slim thin blades, round plug

TI-ES-570-23

Micro Bipolar Scissors, 23cm curved slim thin blades, round plug

TI-ES-571-28

Micro Bipolar Scissors, 28cm curved slim thin blades, round plug

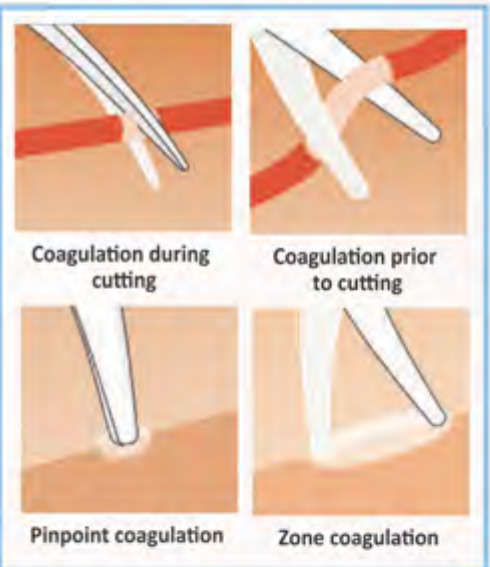

PowerCable

TI-EC-572-00

Power Cable, silicone,
2 banana plugs / round plug, 10 ft

TI-EC-573-00

Power Cable, silicone,
2 banana plugs / round plug, 16 ft

These new Bipolar Clamp Scissors provide powerful grasping and compression of tissue, combined with bipolar coagulation or sealing of blood vessels. Then the tissue may be cut without changing instruments



14 cm, insulated, straight serrated, round plug
TI-EF-574-14 Bipolar Clamp Scissors

14 cm, insulated, curved serrated, round plug
TI-EF-575-14 Bipolar Clamp Scissors

19 cm, insulated, straight serrated, round plug
TI-EF-576-19 Bipolar Clamp Scissors

19 cm, insulated, curved serrated, round plug
TI-EF-577-19



PowerCable

TI-BS-581-00 Cable, silicone, for Bipolar Clamp

Scissors, 10 ft., 2 banana plugs
TI-BS-582-00 Cable, silicone, for Bipolar Clamp

Scissors, 15 ft., 2 banana plugs
TI-BS-583-00 cable, silicone, for Bipolar Clamp

Scissors, 10 ft., Valleylab plug
TI-BS-584-00 cable, silicone, for Bipolar Clamp

Scissors, 15 ft., Valleylab plug



BIPOLAR



**BIPOLAR COAGULATION
FORCEPS Tip-0.4mm**
TI-EB-588-00



**McPHERSON STRAIGHT
FORCEPS 8cmTip-0.4mm**
TI-EB-589-00



**McPHERSON CURVED
FORCEPS 9cmTip-0.4mm**
TI-EB-590-00



**JEWELER
FORCEPS 11cmTip-0.4mm**
TI-EB-591-00



**BIPOLAR FORCEPS
10cm Tip-0.4mm**
TI-EB-592-00



**ADSON FORCEPS
11cm,14cmTip-0.4mm**
TI-EB-593-00

TI-EB-594-00 11cm
TI-EB-595-00 14cm



**ARTERY FORCEPS
STRAIGHT**
TI-EB-596-70 7"



**ARTERY FORCEPS
CURVED**
TI-EB-597-70 7"



**TURNER WARWICK SCISSORS
STRAIGHT**
TI-EB-598-70 7"



**TURNER WARWICK
SCISSORS
CURVED**
TI-EB-599-70 7"

Alms Retractor

- 7cm/2¾" length
- 4 x 4 teeth blunt
- 4mm depth prongs

TI-SR-600-70



Baby Weitlaner S/R Retractor

- 11.5cm/4½" length
- 2 x 3 blunt prongs

TI-SR-601-115



Wests S/R Retractor

- 14cm/5½" length
- 3 x 4 sharp prongs

TI-SR-602-14

Weitlaner S/R Retractor

- 14cm/5½" length
- 3 x 4 blunt prongs

TI-SR-603-14



Mollison S/R Retractor - Child

- 13cm/5¼" length
- 2 x 2 sharp prongs 12mm depth
- Curved

TI-SR-604-14



Mollison S/R Retractor - Adult

- 17cm/6¾" length
- 4 x 4 sharp prongs 14mm depth
- Curved

TI-SR-605-17



BREAST RETRACTORS

Taidoc Moliver Nipple Holding Forceps

Designed for use in reducing nipple height

procedures with minimal tissue manipulation and surgical intervention.



- Consistent results in Nipple Reduction
- No Flaps
- No Sewing
- Physiologic - Does Not Block Lactiferous Ducts
- No Scars Visible
- Heals in 7-10 Days
- Uses a #10 Scalpel Blade



Clayton Moliver, MD FACS
University of Texas Medical Branch
Webster, Texas

Levine Breast Retractor & Implant Protector

Features:

Designed to facilitate closure of the tissues over a prosthesis

This Retractor simplifies exposure and eliminates accidental implant damage when suturing acellular matrix in tissue expander or immediate breast reconstruction. Prevents accidental damage to saline

Prevents accidental damage to saline filled implants. *The Levine Breast Retractor & Implant*

The Levine Breast Retractor & Implant Protector is useful in all breast prosthetic procedures including augmentations as well as reconstructions.



TI-BR-609-00
Levine Breast Retractor
& Implant Protector
Double Ended

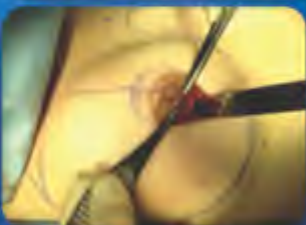

Designed by:
Richard Levine, MD
San Antonio, Texas

BORENSTEIN BREAST AUGMENTATION MASTOPEXY PROTECTOR

safe and effective closure of the surgical wound when performing short scar augmentation mastopexy.

Currently there are no custom made instruments for this purpose. Some surgeons use a scalpel handle while others rely on unaided digital maneuvers.

The essence of the innovation...

The Borenstein Breast Augmentation Mastopexy Protector

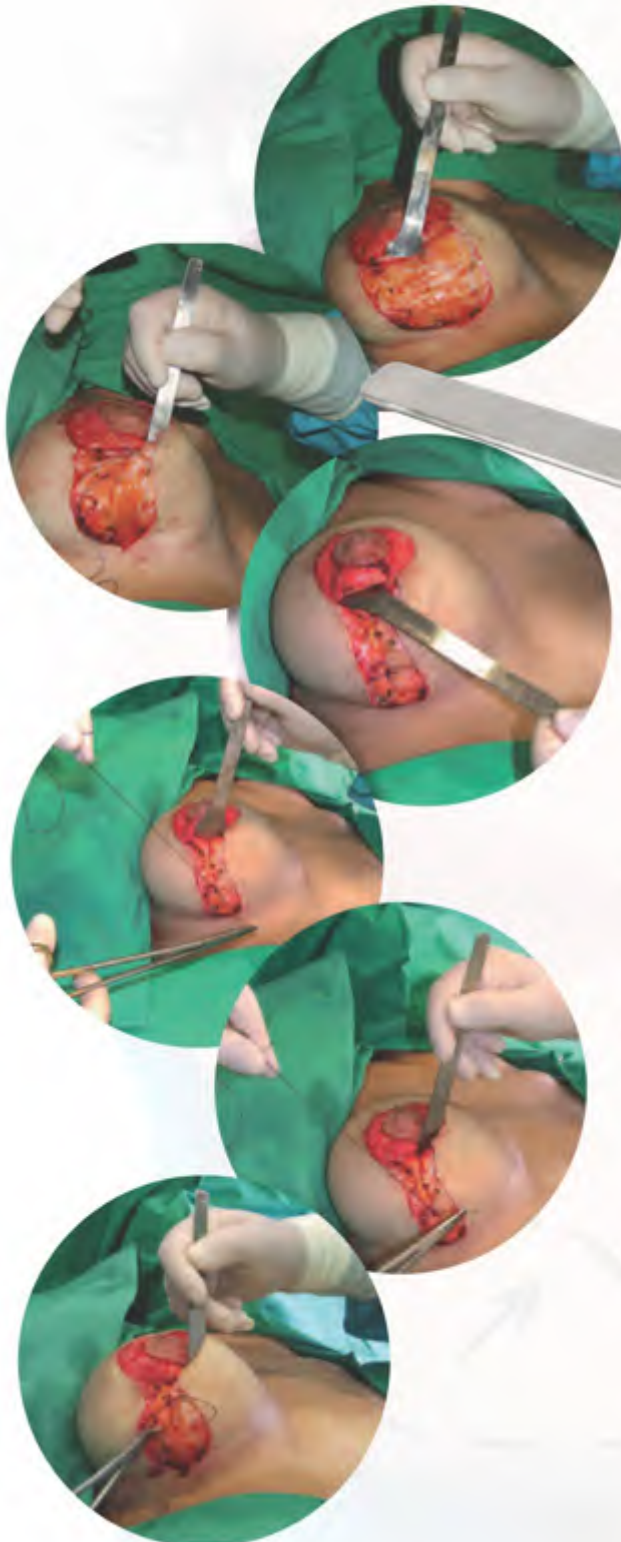

TI-BR-610-00



can effectively protect the breast prosthesis while shaping the breast during short scar augmentation mastopexy thereby allowing safer and better breast formation.

It is a T-shaped tool curved to better align the prosthesis. The device is inserted from above, through the surgical wound at the base of the areola into the surgical pocket. In this position it can effectively protect the prosthesis while the tissue pillars are being sutured.

The NewBorenstein Breast Augmentation Mastopexy Protector is especially designed for procedures such as the LeJour and Hall-Findlay mastopexy.

It can also be of value during breast augmentation facilitating manipulation of the prosthesis after insertion into the surgical pocket. It may help in evaluating the adjustment of the prosthesis within the pocket and improve the visualization of any bleeding.

improve safe and effective closure of the surgical wound when performing breast augmentation surgery..

Currently there are no custom made instruments for this purpose. Some surgeons use a scalpel handle while others rely on unaided digital maneuvers.

The essence of the innovation...

The Borenstein Breast Augmentation Protector can effectively

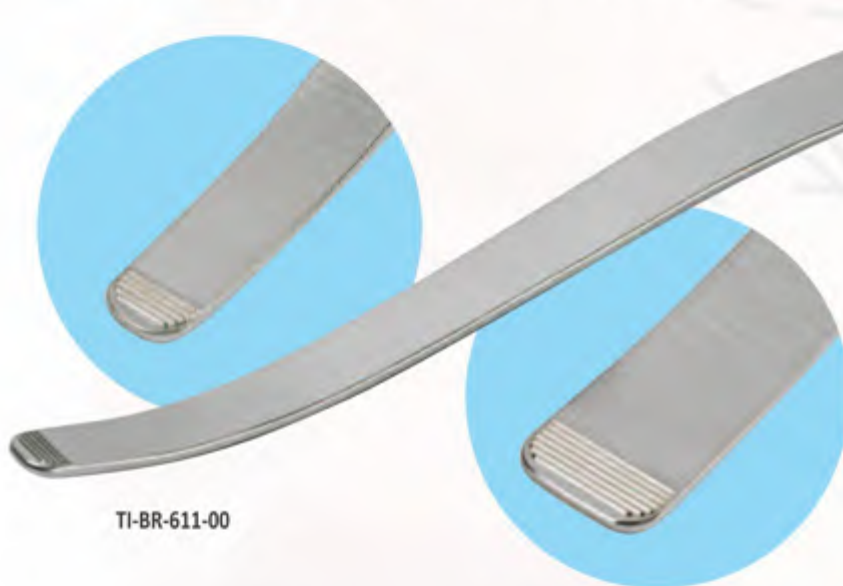

TI-BR-611-00

protect the breast prosthesis while assisting the surgeon by mobilizing the superior flap into a convenient position thereby allowing safer and better surgical wound closure.

The two ends of the instrument differ in size, one end approximately 3 cm in width while the second end is narrower, approximately 1.5 cm. The different size instrument ends allow easier closure of narrow surgical wounds.

Furthermore, the Borenstein Breast Augmentation Protector is curved in order to permit a more natural movement during suturing. Both sides of the Protector are serrated to allow better tissue grip and improve approximation of the wound edges.

MICRO FORCEPS

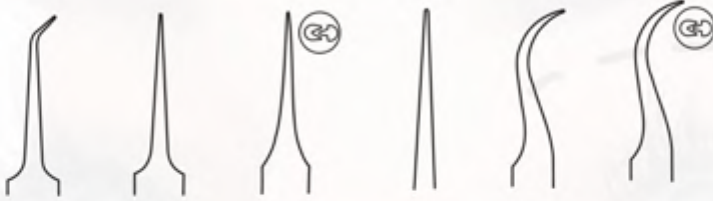

TI-MF-612-00 Angled 5-A TI-MF-613-00 No.5 TI-MF-614-00 Toothed No.5 TI-MF-615-00 No.3 TI-MF-616-00 No.7 TI-MF-617-00 Toothed No.7

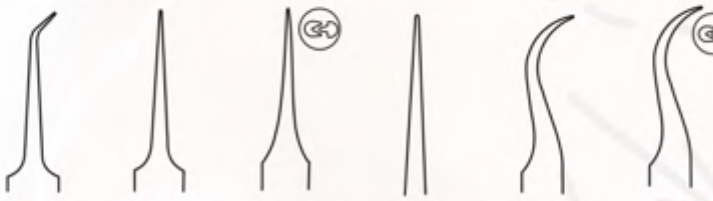

TI-MF-618-00 Angled 5-A Titanium TI-MF-619-00 No.5 Titanium TI-MF-620-00 Toothed No.5 Titanium TI-MF-621-00 No.3 Titanium TI-MF-622-00 No.7 Titanium TI-MF-623-00 Toothed No.7 Titanium

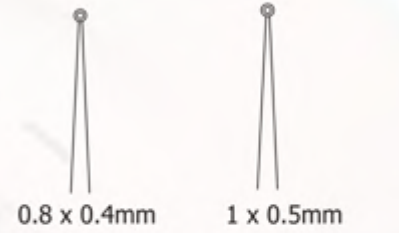

TI-MF-624-70 7" TI-MF-626-70 7"
TI-MF-625-80 8" TI-MF-627-80 8"

TI-MF-628-70 7"
TI-MF-629-80 8"
TITANIUM

MICRO JEWELLER FORCEPS

MICRO FORCEPS ROUND HANDLE

SCALPEL HANDLES



B.P. Handle 3
TI-BP-630-03



B.P. Handle 4
TI-BP-631-04



Scalpel Handle 3
TI-BP-632-03
with scale



B.P. Handle 7
TI-BP-633-07



ROUND. Handle 3
TI-BP-634-03

TEBBETS Style Retractors with serrated tip

With Light Guide	With Light Guide & Suction	Suction Only	Retractor Only	Blades
TI-BR-635-00	TI-BR-648-00	TI-BR-661-00	TI-BR-674-00	16 mm x 8 cm
TI-BR-636-00	TI-BR-649-00	TI-BR-662-00	TI-BR-675-00	16 mm x 18 cm
TI-BR-637-00	TI-BR-650-00	TI-BR-663-00	TI-BR-676-00	24 mm x 9 cm
TI-BR-638-00	TI-BR-651-00	TI-BR-664-00	TI-BR-677-00	24 mm x 10 cm
TI-BR-639-00	TI-BR-652-00	TI-BR-665-00	TI-BR-678-00	25 mm x 10 cm
TI-BR-640-00	TI-BR-653-00	TI-BR-666-00	TI-BR-679-00	25 mm x 12 cm
TI-BR-641-00	TI-BR-654-00	TI-BR-667-00	TI-BR-680-00	25 mm x 15 cm
TI-BR-642-00	TI-BR-655-00	TI-BR-668-00	TI-BR-681-00	25 mm x 18 cm
TI-BR-643-00	TI-BR-656-00	TI-BR-669-00	TI-BR-682-00	30 mm x 9 cm
TI-BR-644-00	TI-BR-657-00	TI-BR-670-00	TI-BR-683-00	30 mm x 12 cm
TI-BR-645-00	TI-BR-658-00	TI-BR-671-00	TI-BR-684-00	30 mm x 15 cm
TI-BR-646-00	TI-BR-659-00	TI-BR-672-00	TI-BR-685-00	36 mm x 16 cm
TI-BR-647-00	TI-BR-660-00	TI-BR-673-00	TI-BR-686-00	36 mm x 19 cm

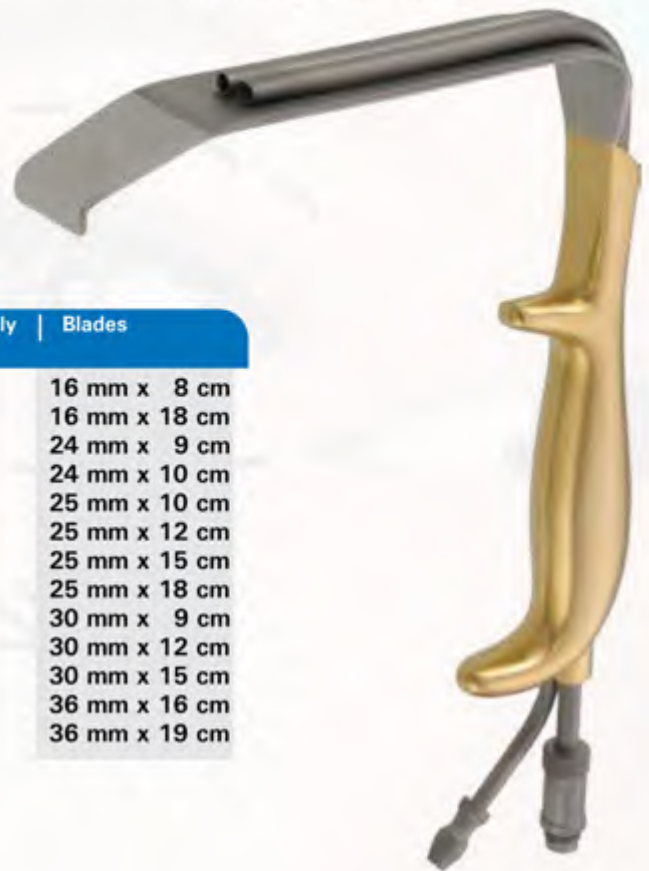

FERRIERA Style Retractors with smooth tip

With Light Guide	With Light Guide & Suction	Suction Only	Retractor Only	Blades
TI-BR-687-00	TI-BR-700-00	TI-BR-713-00	TI-BR-726-00	14 mm x 7 cm
TI-BR-688-00	TI-BR-701-00	TI-BR-714-00	TI-BR-727-00	14 mm x 9 cm
TI-BR-689-00	TI-BR-702-00	TI-BR-715-00	TI-BR-728-00	16 mm x 8 cm
TI-BR-690-00	TI-BR-703-00	TI-BR-716-00	TI-BR-729-00	16 mm x 15 cm
TI-BR-691-00	TI-BR-704-00	TI-BR-717-00	TI-BR-730-00	23 mm x 10 cm
TI-BR-692-00	TI-BR-705-00	TI-BR-718-00	TI-BR-731-00	23 mm x 15 cm
TI-BR-693-00	TI-BR-706-00	TI-BR-719-00	TI-BR-732-00	23 mm x 18 cm
TI-BR-694-00	TI-BR-707-00	TI-BR-720-00	TI-BR-733-00	25 mm x 10 cm
TI-BR-695-00	TI-BR-708-00	TI-BR-721-00	TI-BR-734-00	25 mm x 12 cm
TI-BR-696-00	TI-BR-709-00	TI-BR-722-00	TI-BR-735-00	25 mm x 15 cm
TI-BR-697-00	TI-BR-710-00	TI-BR-723-00	TI-BR-736-00	25 mm x 19 cm
TI-BR-698-00	TI-BR-711-00	TI-BR-724-00	TI-BR-737-00	30 mm x 12 cm
TI-BR-699-00	TI-BR-712-00	TI-BR-725-00	TI-BR-738-00	30 mm x 15 cm



BIGGS Mammoplasty Retractors

With Light Guide	With Light Guide & Suction	Retractor Only	Blades Width
TI-BR-739-00	TI-BR-741-00	TI-BR-743-00	30 mm
TI-BR-740-00	TI-BR-742-00	TI-BR-744-00	50 mm

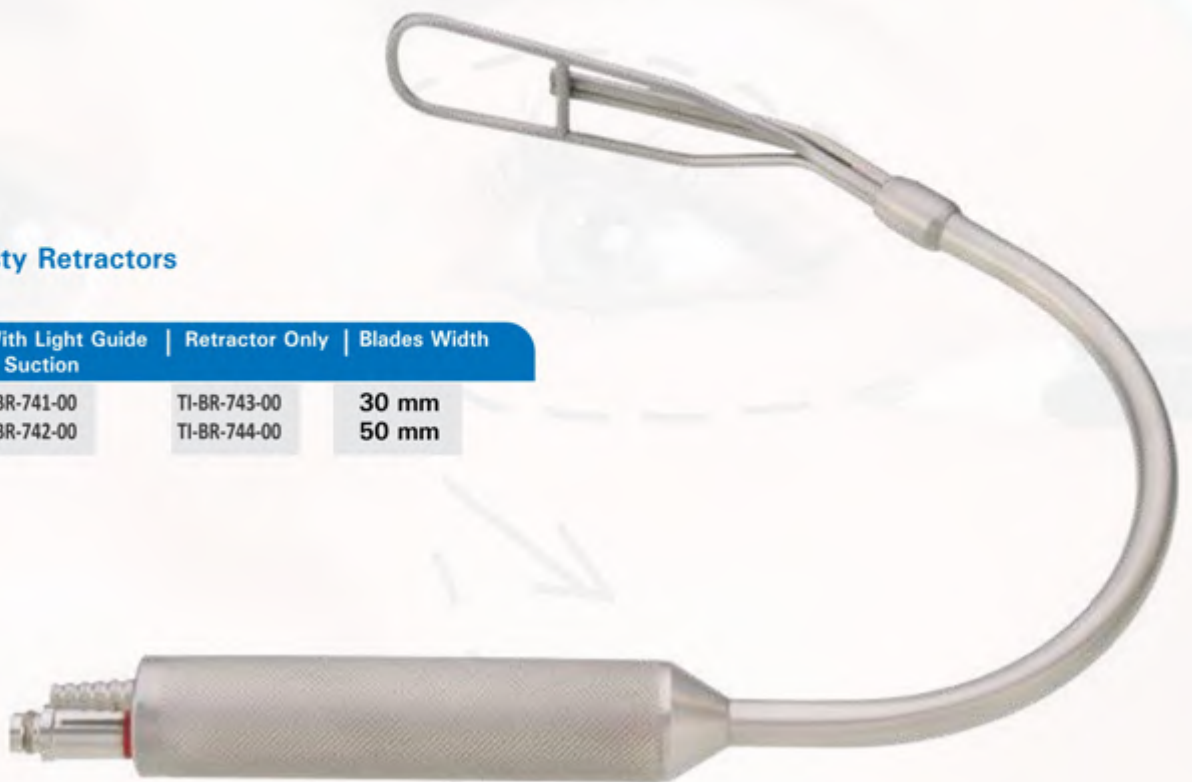

EMORY Style Retractors
for 10 mm scopes

With Suction	Without Suction	Blades with Length
TI-BR-745-00		1" x 4 3/4" (25.4 mm x 120.7 mm)
TI-BR-746-00	TI-BR-747-00	1" x 10" (25.4 mm x 254 mm)
		9/16" x 4 3/4" (14.3 mm x 120.7 mm)

for 5 mm scopes

With Suction	Without Suction	Blades with Length
	TI-BR-748-00	9/16" x 4 3/4" (14.3 mm x 120.7 mm)
	TI-BR-749-00	3/8" x 7" (9.5 mm x 177.8 mm)



Multi Approach Retractor with smooth round tip

	Blades
TI-BR-750-00	23 mm x 18 cm



Face-lift Retractors

With Light Guide	Without Light Guide	Blades
TI-BR-751-00	TI-BR-752-00	22 mm x 11 cm



WIEDER Tongue Depressors Serrated blade

Depressor Alone	With Light Guide	With Light Guide & Suction	Length	Blades
TI-BR-753-00 TI-BR-754-00	TI-BR-755-00 TI-BR-756-00	TI-BR-757-00 TI-BR-758-00	5½" (14 cm) 6" (15 cm)	38mm, Small 45 mm, Large

TI-BR-752-00



AUFRICHT Nasal Retractors

With Light Guide	Without Light Guide	Tip	Length	Blades
TI-BR-759-00	TI-BR-762-00	7 mm	6¼" (16 cm)	45 mm
TI-BR-760-00	TI-BR-763-00	7 mm	7" (18 cm)	45 mm
TI-BR-761-00	TI-BR-764-00	10 mm	7" (18 cm)	45 mm

Fiber Optic Retractors

MALINIAC Nasal Retractors

With Light Guide	Without Light Guide	Blades	Length
TI-BR-765-00	TI-BR-766-00	9 x 45 mm	4" (10 cm)



CONVERSE Nasal Retractors

Length 3½" (9 cm)

With Light Guide	Without Light Guide	Blades
TI-BR-767-09	TI-BR-771-09	10 x 20 mm
TI-BR-768-09	TI-BR-772-09	12 x 30 mm
TI-BR-769-09	TI-BR-773-09	12 x 40 mm
TI-BR-770-09	TI-BR-774-09	12 x 50 mm



FREEMAN Flap Retractors

With Light Guide	Without Light Guide	Blades	Length
TI-BR-775-00	TI-BR-777-00	12 mm	8" (20 cm)
TI-BR-776-00	TI-BR-778-00	25 mm	8" (20 cm)

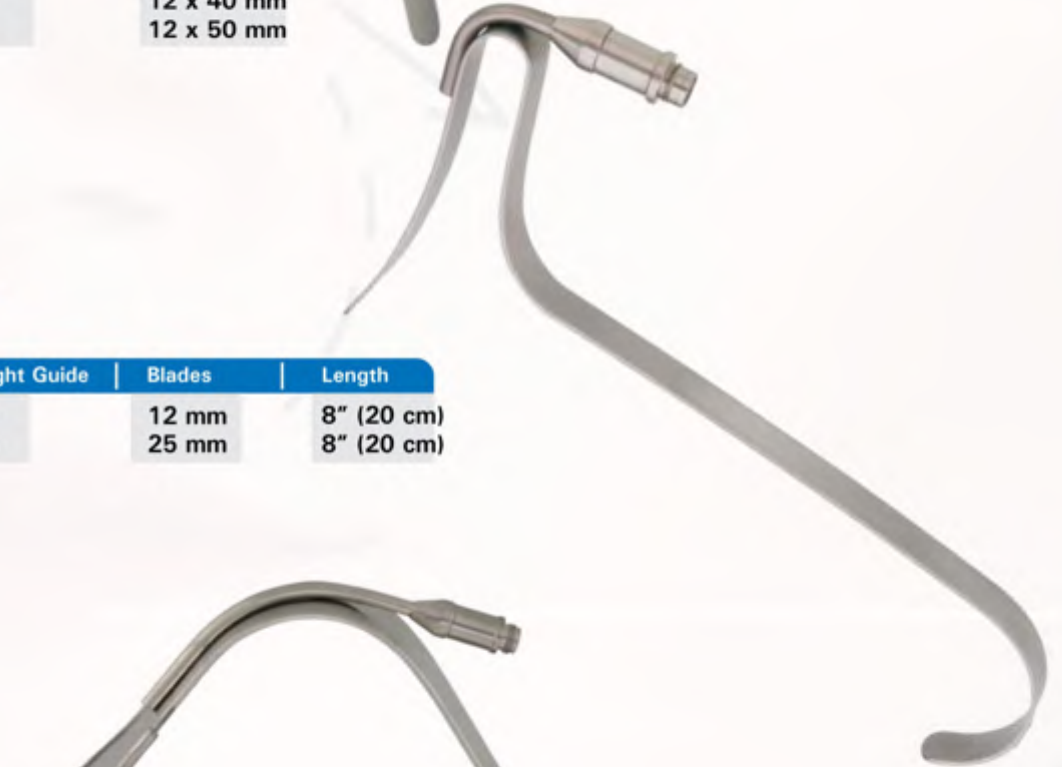

HARRINGTON Retractors

Length 12½" (32 cm)

With Light Guide	With Light Guide & Suction	Retractor Only	Blades
TI-BR-779-32	TI-BR-781-32	TI-BR-783-32	40 x 127 mm
TI-BR-780-32	TI-BR-782-32	TI-BR-784-32	62 x 127 mm





DEAVER Retractors

With Light Guide	Without Light Guide	Blades	Length
TI-BR-785-00	TI-BR-794-00	3/4" (19 mm)	7" (18 cm)
TI-BR-786-00	TI-BR-795-00	1" (25 mm)	8" (20 cm)
TI-BR-787-00	TI-BR-796-00	1" (25 mm)	9" (23 cm)
TI-BR-788-00	TI-BR-797-00	5/8" (16 mm)	9" (23 cm)
TI-BR-789-00	TI-BR-798-00	1" (25 mm)	9" (12 cm)
TI-BR-790-00	TI-BR-799-00	1" (25 mm)	13" (33 cm)
TI-BR-791-00	TI-BR-800-00	1 1/2" (38 mm)	12" (30 cm)
TI-BR-792-00	TI-BR-801-00	2" (50 mm)	12" (30 cm)
TI-BR-793-00	TI-BR-802-00	1 1/2" (38 mm)	13" (33 cm)



DEAVER Pediatric Retractors

Length 8" (20 cm), tail curved to front

With Light Guide	Blades
TI-BR-804-20	5/8" (16mm)
TI-BR-805-20	1" (25 mm)



Breast Spatulas with handle

Length 12 1/2" (31.5 cm), semi malleable

Serrated	Smooth	Working Tip
TI-BR-806-315	TI-BR-808-315	1" x 6" (25 mm x 18 cm)
TI-BR-807-315	TI-BR-809-315	1 1/2" x 6" (38 mm x 18 cm)



**Breast Retractors
double ended**

Retractor Only	With Light Guide	Length	Blades
TI-BR-810-315		8 1/4" (21 cm)	20 mm x 60 mm, 34 mm x 70 mm
TI-BR-811-315		9 1/2" (24 cm)	22 mm x 55 mm, 38 mm x 70 mm
TI-BR-812-315	TI-BR-813-315	12 1/2" (31 cm)	22 mm x 55 mm, 38 mm x 70 mm

Retractors

Lead Hand

RICHARDSON-EASTMAN Retractors

double ended



	Size	Width & Depth	Blade Size
TI-RE-814-00	Set of 2		
TI-RE-815-00	10" (25.4 cm), Small	3/4" x 1 1/8" 1 1/8" x 1 1/2"	19 x 29mm 29 x 38mm
TI-RE-816-00	10 5/8" (27 cm), Large	1 1/2" x 1 3/4" 1 5/8" x 2 1/2"	38 x 45 mm 41 x 64 mm



US ARMY (PARKER LANGENBECK) Retractors

Length 8 1/4" (21 cm), double ended

	Fig.	Blade
TI-RE-817-21	Set of 2	
TI-RE-818-21	1	21 x 24 mm / 44 x 15 mm
TI-RE-819-21	2	25 x 24 mm / 44 x 15 mm

RIBBON Retractors

Malleable



	Width	Length
TI-RE-820-00	1/4" (0.6 cm)	7" (18cm)
TI-RE-821-00	2/5" (1 cm)	7" (18cm)
TI-RE-822-00	1/2" (1.3 cm)	7" (18cm)
TI-RE-823-00	3/5" (1.5 cm)	7" (18cm)
TI-RE-824-00	3/4" (1.9 cm)	7" (18cm)
TI-RE-825-00	1" (2.5 cm)	7" (18cm)
TI-RE-826-00	1/2" (1.9 cm)	13" (33cm)
TI-RE-827-00	1" (2.5 cm)	13" (33cm)
TI-RE-828-00	1 1/4" (3.1 cm)	13" (33cm)
TI-RE-829-00	2" (5 cm)	13" (33cm)
TI-RE-830-00	3" (7.5 cm)	13" (33 cm)

Lead Hand for hand surgery

	Size
TI-RE-831-00	14" (35cm), for Adults
TI-RE-832-00	9 1/2" (24 cm), for Children



FREEMAN Face-Lift Retractors

Length 7" (18 cm), with bent neck

	Blade	Prongs
TI-RE-833-18	38 mm	4 sharp



FREEMAN RAKE Retractors

Length 7" (18 cm)

	Blades	Prongs
TI-RE-834-18	19 mm	4 blunt (2 recessed)
TI-RE-835-18	19 mm	4 sharp (2 recessed)
TI-RE-836-18	22 mm	4 sharp
TI-RE-837-18	22 mm	4 sharp (2 recessed)
TI-RE-838-18	38 mm	4 sharp
TI-RE-839-18	38 mm	4 sharp (2 recessed)

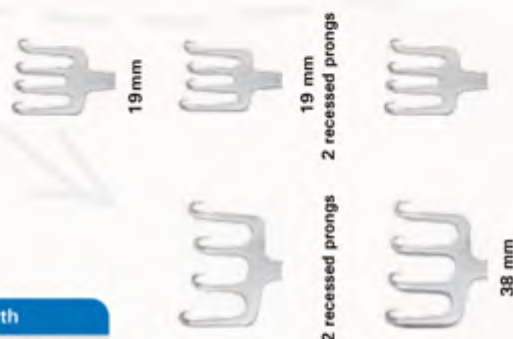

	Blades	Prongs	Length
TI-RE-840-18	38 mm	4 sharp (2 recessed)	4" (10 cm)
TI-RE-841-18	25 mm	4 sharp (2 recessed)	4 1/4" (10.8 cm)
TI-RE-842-18	25 mm	4 sharp (in-line prongs)	4 1/4" (10.8 cm)
TI-RE-843-18	25 mm	4 sharp	4 3/4" (12.0 cm)

FREEMAN mini RAKE Retractors

Length 2" (5 cm), with thumb ring

	Blades	Prongs
TI-RE-844-05	19 mm	4 sharp
TI-RE-845-05	38 mm	4 sharp



FREEMAN RAKE Retractors

Length 4" (10 cm)

	Blades
TI-RE-846-10	22 mm
TI-RE-847-10	38 mm



GORNEY RAKE Retractors

Length 3" (7.5 cm), with spring neck

	Blades	Length
TI-RE-848-75	38 mm	3" (7.5 cm)
TI-RE-849-75	38 mm	4 1/4" (10.8 cm)



RETRACTORS



MILLER RAKE
RETRACTOR 9 PRONGS
TI-BR-850-00



MULTI PURPOSE
RETRACTOR
12cm x 2.3cm BLADE
TI-BR-851-12



YANCOSKIE
ABDOMINOPLASTY RETRACTOR
TI-BR-852-00



GORNEY RAKE
RETRACTOR 4 PRONGS
TI-BR-853-00



SPATULA
RETRACTOR
31.5cm 1 x 6 BLADE
TI-BR-854-315



DOUBLE ENDED
BREAST RETRACTOR
24.5cm, 7/8" x 1 1/2"
TI-BR-855-245

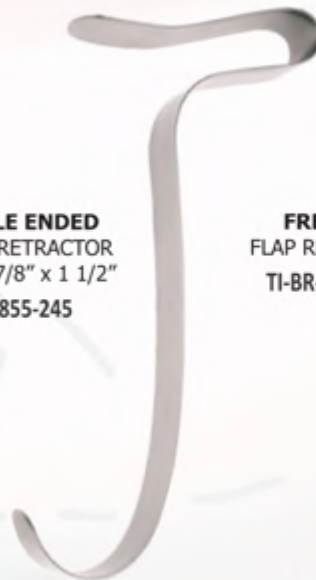

FREEMAN
FLAP RETRACTOR
TI-BR-856-00



FREEMAN RAKE
RETRACTOR 4 PRONGS
TI-BR-858-00

LIGHTED FREEMAN FLAP
RETRACTOR WITH FIBER OPTIC LIGHT
TI-BR-857-00

BREAST RAKE RETRACTORS



**GORNEY MAXWELL
RAKE RETRACTOR**
TI-BR-859-75 With spring,
3½" 7.5cm 38mm wide

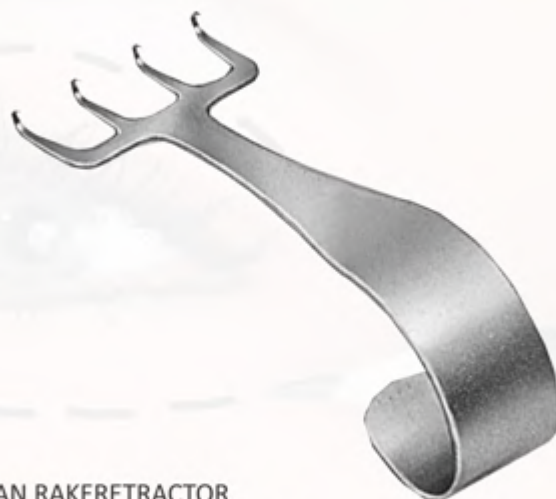

FREEMAN RAKE RETRACTOR
TI-BR-860-10 4" 10cm, short handle w/thumb ring,
4 sharp prongs, 1½" 4cm wide, s.s.



FREEMAN RAKE RETRACTOR TI-BR-861-18
7" 18cm, double ended,
4 sharp prongs, all same length,
1½" 4cm wide, s.s. MAXWELL FLAP TI-BR-862-04



FREEMAN RAKE RETRACTOR TI-BR-863-18 7" 18cm, double ended,
4 sharp prongs,
1½" 4cm wide, s.s.



4" 10cm,
4 sharp prongs, all same length, 22mm wide, s.s.
TI-BR-864-10



4" 10cm,
4 sharp prongs, all same length,
1½" 38mm wide, s.s. MAXWELL FLAP RETRACTOR
TI-BR-865-10

Retractors

Rake Retractors

MAXWELL FLAP Retractors

Length 4" (10 cm)

	Blades
TI- BR-866-10	22 mm
TI- BR-867-10	38 mm



Coronal Brow Lift Retractors

Length 7" (18 cm), 7 prongs

	Blades Width	Grip
TI- BR-868-18	70 mm	
TI- BR-869-18	70 mm	reverse



Coronal Lift Retractor

Length 8 1/4" (21 cm), 6 prongs

	Blades Width
TI- BR-870-21	7" (18 cm)



YANCOSKIE Abdominoplasty Retractor

Length 7 1/2" (19 cm), 6 prongs

	Blades Width
TI- BR-871-19	6" (15 cm)



ANDERSON Bear Claw Retractors

2 1/4" (7 cm)	4 1/2" (11 cm)	6 1/4" (16 cm)	Prongs
TI- BR-872-07	TI- BR-874-11	TI- BR-876-16	3 sharp
TI- BR-873-07	TI- BR-875-11	TI- BR-877-16	5 sharp



CONVERSE Alar Retractors

Length 4 3/4" (12 cm), double ended

	Blades
TI- BR-878-12	10 mm / 14 mm sharp prongs
TI- BR-879-12	10 mm / 14 mm blunt prongs



MILLARD (ADSON) Hooks Forceps

double hooks forceps 1 x 2 teeth, with thimble

	Length	Wide Hook
TI- BR-880-10	4" (10 cm)	10 mm



MARTINEZ KILNER Retractors

2 sharp hooks, with thimble

	Length	Tip
TI- BR-881-08	3 1/4" (8 cm)	10 mm
TI- BR-882-075	4 1/4" (11.5 cm)	7.5 mm



Swivel



Thimble Hooks

Blade (18 mm)

Single Hook	Double Hook	
TI- BR-883-18	TI- BR-885-18	right handed
TI- BR-884-18	TI- BR-886-18	left handed



LOGAN Bow Lip traction retractors

Without Teeth	With Teeth	Width	Size
TI- BR-887-00	TI- BR-890-00	1" (25 mm)	11 cm/4 1/4"
TI- BR-888-00	TI- BR-891-00	1 1/4" (32 mm)	15 cm/6"
TI- BR-889-00	TI- BR-892-00	1 3/8" (35 mm)	18 cm/7"



RAGNELL-DAVIS Retractor

double ended, delicate

	Length
TI- BR-893-15	6" (15 cm)



RAGNELL Retractors

double ended

	Insulated blade	Length
TI- BR-894-14		5 1/2" (14 cm)
TI- BR-895-15	TI- BR-896-15	6" (15 cm)



Retractors

Rake Retractors, Nasal Retractors

SENN Retractors

Length 6 ¼" (16 cm) Blade 7 x 8.5 mm

Sharp	Blunt	Prongs
TI-RE-897-16	TI-RE-898-16	3



Non conductive insulated blade

Sharp	Blunt	Prongs
TI-RE-899-00	TI-RE-900-00	3



DESMARRRES Lid Retractors

Length 5 ½" (14 cm), Full blades

Blades		Insulated Blades
10 mm	TI-RE-901-14	TI-RE-905-14
12 mm	TI-RE-902-14	TI-RE-906-14
14 mm	TI-RE-903-14	TI-RE-907-14
16 mm	TI-RE-904-14	TI-RE-908-14

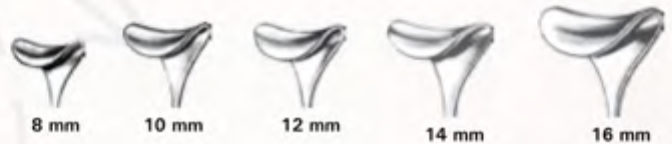

COTTLE Alar Nasal Hook

	Blade size	Length
TI-RE-909-14	12 x 13 mm	5 ½" (14 cm)



JAEGER Lid Plate / Suturing Specula

Sharp	Insulated	Length
TI-RE-910-11	TI-RE-911-11	4 ¾" (11 cm)



KASDEN Retractor

double ended

	Length
TI-RE-912-165	6 ½" (16.5 cm)



SHEEN PARKES Nasal retractor

Length 6 ¼" (16 cm)

	Blade
TI-RE-913-16	10mm



SHEEN Retractor

Length 6" (15 cm)

	Blade
TI-RE-914-15	6.5 mm



O'CONNER (IRIS) Hooks
sharp

	Length
TI-RE-915-125	5" (12.5cm)
TI-RE-916-16	6 1/4" (16cm)



CONVERSE Skin Hooks

Length 7 1/2" (19 cm)

	Size
TI-RE-917-19	small
TI-RE-918-19	large



JOSEPH Skin Hooks

Length 6 1/4" (16 cm)

Round Handle	Sharp
TI-RE-919-16	1 prong
TI-RE-920-16	2mm, 2 prongs
TI-RE-921-16	5mm, 2 prongs
TI-RE-922-16	7mm, 2 prongs
TI-RE-923-16	10 mm, 2 prongs



KLEINERT KUTZ Hooklets

Length 6 1/4" (16 cm)

	Tip
TI-RE-924-16	3 mm
TI-RE-925-16	5 mm
TI-RE-926-16	7 mm



McCOY Micro Dermal Hook

	Length
TI-RE-927-13	5" (13 cm)



COTTLE Mucos Hook

	Length
TI-RE-928-16	6 1/4" (16 cm)



FRAZIER Dura & Skin Hooks

Sharp	Blunt	Length
TI-RE-929-13	TI-RE-930-13	5 1/4" (13cm)



TYRELL Skin Hook

Sharp	Length
TI-RE-930-13	5" (13 cm)



GRAEFE (IRIS) Hooklets

Length 6 1/4" (16 cm)

Sharp	Blunt
TI-RE-931-16	TI-R-932-16



Retractors

Skin Hooks, Retractors

GUTHRIE Hook Retractors

Length 5" (12.5 cm)

Sharp	Fig.	Tip
TI-RE-933-125		1.0mm
TI-RE-934-125	1	1.5mm
TI-RE-935-125	2	2.0 mm



BARSKY Double Skin Hooks

	Length	Width
TI-RE-936-15	6" (15 cm)	5 mm
TI-RE-937-16	6 1/4" (16 cm)	9 mm



KILNER Skin Hook

Very delicate, with round handle

	Length
TI-RE-938-15	6" (15 cm)



GILLIES Skin Hooks, delicate

Length 7" (18 cm)

	Fig.
TI-RE-939-18	1
TI-RE-940-18	2



COTTLE Nasal Hooks

Sharp / Sharp	Length
TI-RE-941-15	6" (15 cm)



ROLLET Rake Retractor

4 sharp prongs

	Length
TI-RE-942-13	5" (13 cm)



MILLER Rake Retractor

9 prongs

Blunt	Sharp	Length
TI-RE-943-135	TI-RE-944-135	5 1/4" (13.5cm)



COTTLE-NEIVERT Double Hook Retractor

double ended, blunt hooks, with needle guide

	Length
TI-RE-945-21	8 1/4" (21 cm)



FOMON Nasal Retractors

double ball end prongs

	Length
TI-RE-946-16	6 1/4" (16 cm)



Non conductive insulated blade

TI-RE-947-00	single ball end prong
TI-RE-948-00	double ball end prongs



Retractors

Skin Retractors, Self Retaining Retractors

FARR Spring Retractors

Length 5½" (14 cm)

	Opening
TI-RE-949-14	6.3 cm

ALM Skin Retractors

self retaining

Sharp	Blunt	Length
TI-RE-950-10		4" (10 cm)

HOLZHEIMER Skin Retractors

4 x 4 Prongs, self retaining

Sharp	Blunt	Length
TI-RE-951-10	TI-RE-952-10	4" (10 cm)

WEITLANER BABY Retractors

2 x 3 Prongs, self retaining

Sharp	Blunt	Length
TI-RE-953-11	TI-RE-954-11	4¼" (11 cm)

WEITLANER Retractors

3 x 4 Prongs, self retaining

Sharp	Blunt	Length
TI-RE-955-125	TI-RE-956-125	5" (12.5 cm)
TI-RE-956-165	TI-RE-957-165	6½" (16.5 cm)

GELPI skin retractors

self retaining

	Length
TI-RE-958-11	4½" (11 cm)
TI-RE-959-16	6¼" (16 cm)
TI-RE-960-18	7" (18 cm)



Breast Dissectors



Spatulated Dissector

	Length
TI-BD-961-33	13" (33 cm)



JACOBS Breast Dissector

	Length
TI-BD-962-33	13" (33 cm)



AGRIS-DINGMAN Breast Dissectors

Length 14 1/4" (36 cm), graduated

	Length
TI-BD-963-36	Pair (set of 2), Left & Right
TI-BD-964-36	
TI-BD-965-36	



McCOLLUM-DINGMAN Submammary Dissector

	Length
TI-BD-966-30	12" (30 cm)



McCOLLUM-DINGMAN Breast Dissectors

	Length
TI-BD-967-315	12 1/2" (31.5 cm)
TI-BD-968-41	16 1/4" (41.0 cm)



REYNOLDS Transauxillary Breast Dissectors

Full blade	Fenestrated	Length
TI- BD-969-33	TI- BD-97133	13" (33 cm)
TI- BD-970-40	TI- BD-972-40	16" (40 cm)



Breast Dissectors angulated blades

Malleable	Rigid	Rigid	Length
TI- BD-973-33	TI- BD-975-33	TI- BD-977-33	13" (33 cm)
TI- BD-974-40	TI- BD-976-40	TI- BD-978-40	16" (40 cm)

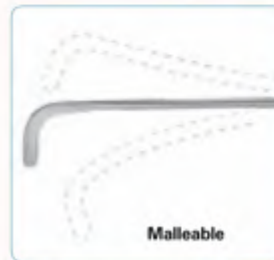

Breast Dissectors spatulated blades

Malleable	Rigid	Rigid	Length
TI- BD-979-33	TI- BD-981-33	TI- BD-983-33	13" (33 cm)
TI- BD-980-33	TI- BD-982-33	TI- BD-984-33	16" (40 cm)

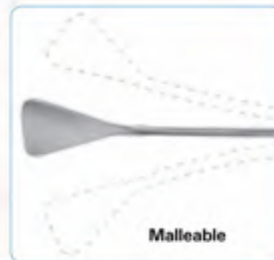

Breast Dissectors oval spatulated blades

Malleable	Rigid	Rigid	Length
TI- BD-985-33	TI- BD-987-33	TI- BD-989-33	13" (33 cm)
TI- BD-986-33	TI- BD-988-33	TI- BD-990-33	16" (40 cm)

EMORY Style Breast Dissector curved, blunt blade

Length
TI- BD-991-30
12" (30 cm)



V-Shaped Breast Dissector

Lightweight detachable resin handle



	Total length	Shaft length	Tip Width
TI-BD-992-46	18 ¹ / ₈ " (46 cm)	12 ¹ / ₂ " (31.8 cm)	¹ / ₂ " (13 mm)

Hockey Stick Breast Dissector

Lightweight detachable resin handle



	Total length	Shaft length	Tip Width
TI-BD-992-46	18 ¹ / ₈ " (46 cm)	12 ¹ / ₄ " (31.1 cm)	1 ¹ / ₈ " (28 mm)

Bullet and Round Tip Breast Dissector, without tip

Includes 4 interchangeable tips & one lightweight detachable resin handle

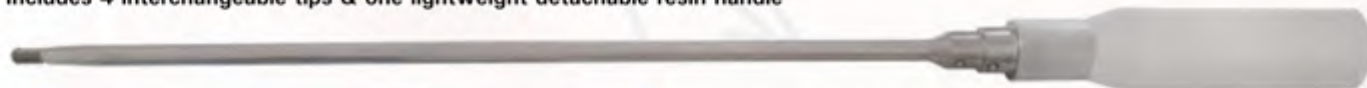

	Total length	Shaft length
TI-BD-993-508	20" (50.8 cm)	12 ¹ / ₄ " (31.1 cm)

Trocar Breast Tubes



	Size	Total length
TI-BD-994-356	Large, (17.3 mm ID, 19 mm OD)	14" (35.6 cm)
TI-BDI-995-343	Small, (14 mm ID, 16 mm OD)	13 ¹ / ₂ " (34.3 cm)

Accessories

for Transumbilical Breast Augmentation Dissectors

Bullet tip	Size	For
TI-BDI-996-00	Large, (17.2 mm wide x 34.2 long)	TI-TI-998-00
TI-BD-997-00		TI-TI-999-00

Round tip	Size	For
TI-BD-1000-00	Large, (17.2 mm wide x 29.7 long)	TI-TI-1002-00
TI-BD-1001-00		TI-TI-1003-00

Handle
TI-BD-1004-00



Scalp Elevators
Length 9 3/4" (24 cm)



	Blade	Shape
TI-FD-1005-24	12.5 mm wide	slightly curved



	Blade	Shape
TI-FD-1006-125	12.5 mm wide	slightly curved



	Blade	Shape
TI-FD-1007-125	12.5 mm wide	"S" Shaped



	Blade	Shape
TI-FD-1008-00	15 mm wide	slightly curved



	Blade	Shape
TI-FD-1009-00	7 mm wide	straight



	Blade	Shape
TI-FD-1010-00	7 mm wide	quarter curved



	Blade	Shape
TI-FD-1011-00	7 mm wide	fully curved

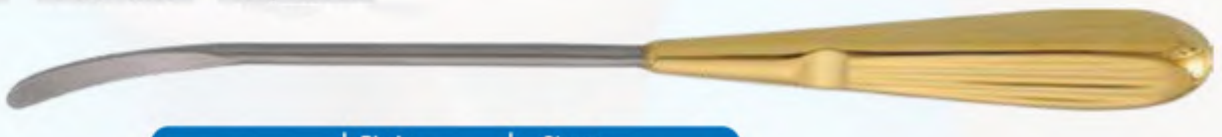

	Blade	Shape
TI-FD-1012-00	7 mm wide	half curved

Forehead & Facelift Endo Dissectors

Scalp Elevators, Frontotemporal

Scalp Elevators

Length 9¾" (24 cm), with Suction

	Blade	Shape
TI-FD-1013-00	7 mm wide	slightly curved



Length 10½" (26 cm), with Suction

	Blade	Shape
TI-FD-1014-00	8.5 mm wide	slightly curved



Frontotemporal Dissectors

	Length / Tip	Shape
TI-FD-1015-225	9" (22.5 cm) / 5 mm	slightly curved



	Length / Tip	Shape
TI-FD-1016-23	9" (23 cm) / 7 mm	slightly curved



	Length / Tip	Shape
TI-FD-1017-23	9" (23 cm) / 10 mm	slightly curved



Frontoglabbellar Dissectors

Length 10½" (26.5 cm)

	Tip	Shape
TI-FD-1018-265	7 mm	"S"-Shaped



Flap Dissector

Length 9½" (23.5 cm)

	Tip	Shape
TI-FD-1019-235	5 mm	straight



Flap Dissector

Length 9½" (23.5 cm)



	Tip	Shape
TI-FD-1020-235	5 mm	straight

Zygomatic Arch Elevator

Length 8¾" (20.5 cm)



	Blade	Shape
TI-FD-1021-205	5 mm	straight

Orbital Rim Dissector

Length 9" (22.5 cm)



		Shape
TI-FD-1022-225		slightly curved

Temporal T- Dissector

Length 9½" (23.5 cm)



	Tip	Shape
TI-FD-1023-235	10 mm	straight

Periosteal Elevators

Length 10" (25 cm)



	Tip	Shape
TI-FD-1024-25	12 mm	"S"-Shaped

Periosteal Spreaders

Length 9¾"(24cm)



	Blade Width	Shape
TI-FD-1025-24	8 mm	"S"-Shaped

Length 9¾"(24cm)



	Blade Width	Shape
TI-FD-1026-24	10 mm	"S"-Shaped

Forehead & Facelift Endo Dissectors Periosteal Elevators, Nerve Protector & Knife

Arcus Marginalis Dissectors

Length 9 3/4" (24 cm)

	Tip	Shape
TI-FD-1026-24	10 mm	"S"-Shaped

Midface Facial Dissectors

Length 9 3/4" (24 cm)

	Tip	Shape
TI-FD-1027-24	12 mm wide	Multiple curves

Transoral Dissectors

Length 9 3/4" (23.5 cm)

	Shape
TI-FD-1028-235	curved

Corrugated & Procerus Muscle Dissector

Length 7 3/4" (19.5 cm)

	Blade
TI-FD-1029-195	4.7 mm

Nerve Protectors

Length 6 3/4" (17 cm)

	Blade	Shape
TI-FD-1030-195	4.5 mm	Curved Left

Nerve Protectors

Length 6 3/4" (17 cm)

	Blade	Shape
TI-FD-1031-17	4.5 mm	Curved Right

Nerve Cutting Knife

Length 6 3/4" (17 cm)

	Blade	Shape
TI-FD-1032-17	3 mm	Curved



Knife Handle, for plastic surgery

	Length
TI-FD-1033-205	8 ¼" (20.5cm)



Nerve Hooks
Length 9 ¾" (24 cm)

	Shaft
TI-FD-1034-24	Rigid
TI-FD-1035-24	Malleable



Nerve Dissector
Length 9 ¾" (24 cm)

	Blade	Style
TI-FD-1036-24	4.7 mm	"Cobra"



Nerve Hooks
Length 9 ¾" (24 cm)

Left

Left Hook	Right Hook
TI-FD-1037-24	Left
TI-FD-1038-24	Right

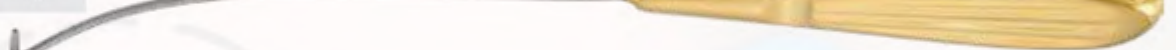

Right

DI GERONIMO BREAST CLAMP

TI-FT-1039-00

Fill Tube

Insertor Clamp

Use to reinsert the fill tube into the breast implant valve. Saves time. Special jaw configuration securely holds

fill tube end, making reinsertion easy. Use if the tube slips out during filling procedure. Use if more or less saline solution is required. Decreases risk to breast implant integrity.

Take the guesswork out of breastwork!
Lalonde * Breast Sizers

Intraoperative measurement of
pedicle or pedicle and skin for
better size and symmetry in

- Reduction
- Reconstruction
- Mastopexy
- Asymmetry

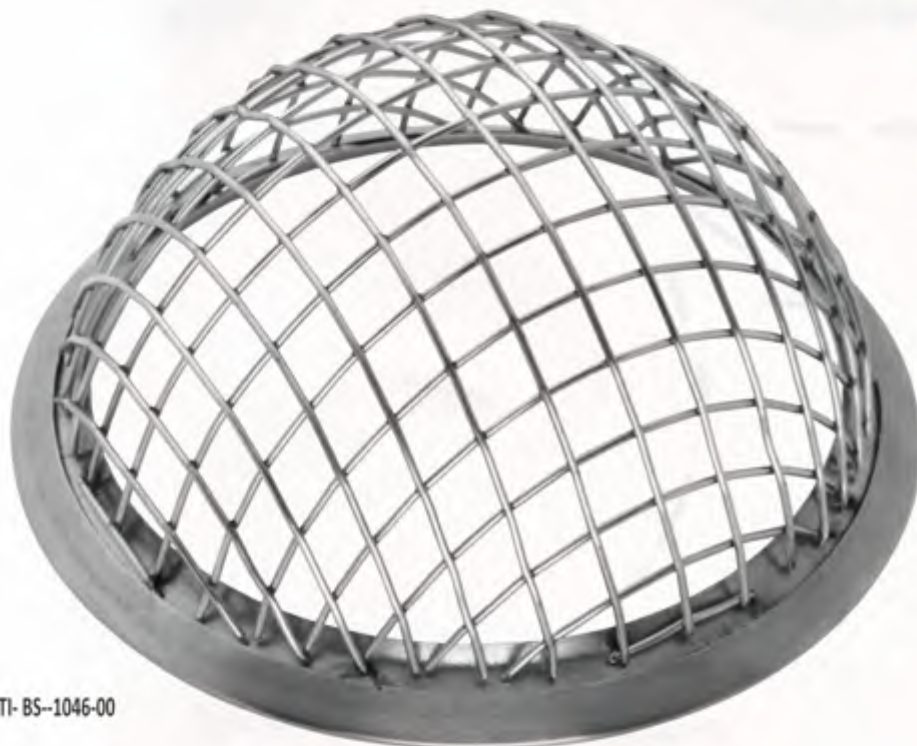

TI-BS-1046-00

- | | |
|---------------|-----------------------------|
| TI-BS-1040-00 | Small, size 1 / 250cc |
| TI-BS-1041-00 | Medium, size 2 / 375cc |
| TI-BS-1042-00 | Large, size 3 / 500cc |
| TI-BS-1043-00 | Extra Large, size 4 / 625cc |
| TI-BS-1044-00 | x, size 5 / 750cc |
| TI-BS-1045-00 | Lalonde Breast Sizer Set |

Simple • Sturdy • Accurate

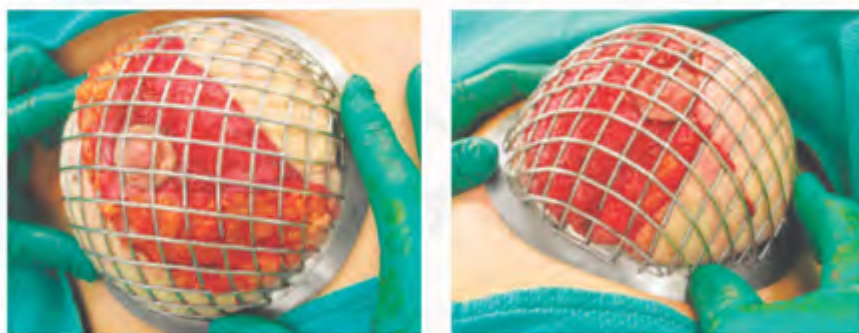

Left and right reduction photos —
pedicle and skin with size 2 Lalonde Breast Sizer

Consists of 1 each: TI-BS-1047-00
TI-BS-1048-00

WALDEN BREAST MARKER

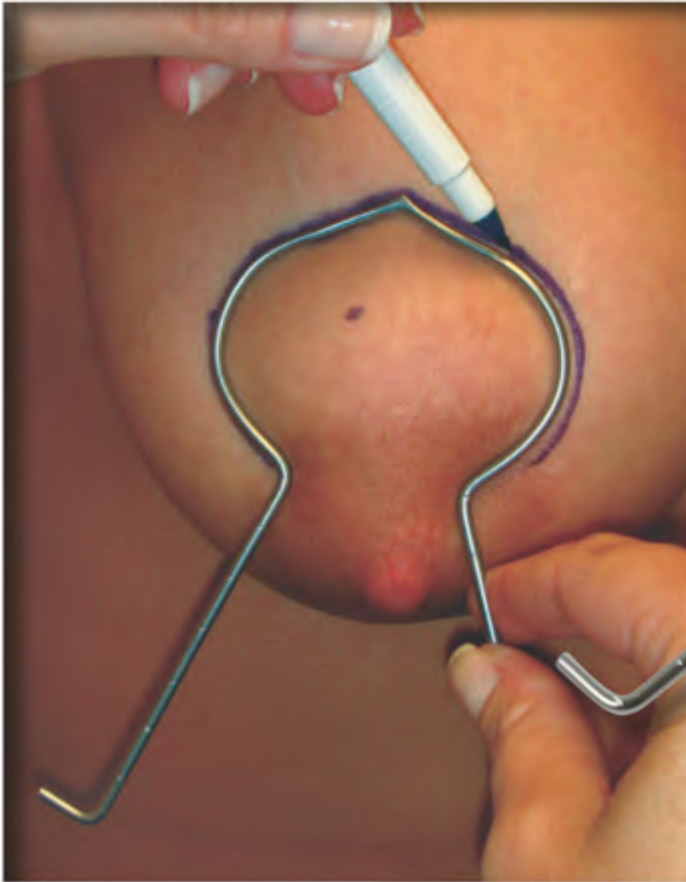

TI- WB-1049-00

Designed by Jennifer L. Walden, MD, Austin, TX

The Walden Breast Marker, made of thin but durable wire, is a useful tool for preoperative breast marking whether for reduction or mastopexy. The 14 cm circumference mosque pattern aids with creating a circular nipple-areola complex with less eccentricity and need for tailoring after inset, and is useful for marking both vertical and pattern of Wise reductions.

The vertical limbs set at 7 cm with shorter gradations are an ideal length, with 90 degree angles pointing laterally to aid in marking the takeoff of horizontal limbs in pattern of Wise reductions.

GROSSMAN Areola Marker

Blades	
TI-BM-1050-40	4 sizes in 1
TI-BM-1050-44	40 / 44 / 48 / 52 mm
TI-BM-1050-48	
TI-BM-1050-52	



FREEMAN Areola Markers

with inner markings, made from light weight aluminium

Size (2 in 1)	
TI-BM-1051-34	34 / 36 mm
TI-BM-1052-38	38 / 42 mm
TI-BM-1053-45	45 / 50mm



FREEMAN Areola Markers

stainless steel

Size (1 in 1)	
TI-BM-1054-32	32mm
TI-BM-1055-34	34mm
TI-BM-1056-36	36mm
TI-BM-1057-38	38mm
TI-BM-1058-42	42mm
TI-BM-1059-45	45mm
TI-BM-1060-50	50mm



FREEMAN Areola Markers

stainless steel, double sided

Size (2 in 1)	
TI-BM-1060-34	34 / 36mm
TI-BM-1061-38	38 / 42mm
TI-BM-1062-42	42 / 45mm
TI-BM-1063-45	45 / 50 mm



ACKERMANN Areola Markers

Length 4" (10 cm)

Size	
TI-BM-1064-14	5½" (14 cm), small
TI-BM-1065-16	6¼" (16 cm), large



AREOLA MARKERS

Freeman Areola Marker

Code	Diameter
TI- BM-1066-36	36mm Ø
TI- BM-1067-38	38mm Ø
TI- BM-1068-40	40mm Ø
TI- BM-1069-42	42mm Ø
TI- BM-1070-45	45mm Ø



Freeman Double Ended Areola Marker

Code	Diameter
TI- BM-1071-38	38/42mm Ø
TI- BM-1072-42	42/45mm Ø



Howarth Elevator

- 4 sizes in 1
- Marking 40mm/44mm/48mm & 52mm Ø

TI- BM-1073-40



Galvao Nipple Markerz

Code	Diameter
TI- BM-1074-40	40mm Ø standard
TI- BM-1075-50	50mm Ø large



McKissock Keyhole Breast Reduction Marker

Code	Diameter
TI- BM-1076-38	38mm Ø
TI- BM-1077-42	42mm Ø
TI- BM-1078-45	45mm Ø



Castroviejo Measuring Caliper

- 7cm/2¾" length
- Measuring range 0 to 25mm

Straight	Curved
TI- BM-1079-07	TI- BM-1080-07



Freeman "Cookie Cutters" (Areola Markers)



TI- BM-1081-00

- TI- BM-1082-25 25mm dia.
- TI- BM-1083-30 30mm dia.
- TI- BM-1084-32 32mm dia.
- TI- BM-1085-34 34mm dia.
- TI- BM-1086-36 36mm dia.
- TI- BM-1087-38 38mm dia.

- TI- BM-1088-40 40mm dia.
- TI- BM-1089-42 42mm dia.
- TI- BM-1090-45 45mm dia.
- TI- BM-1091-50 50mm dia.
- TI- BM-1092-52 52mm dia.
- TI- BM-1093-55 55mm dia.
- TI- BM-1094-60 60mm dia.



- TI- BM-1095-38 38/42mm dia.
- TI- BM-1096-42 42/45mm dia.

Halpern Breast Markers

Grossmann Areola Marker TI- BM-1097-18 18mm dia.



40, 44, 48 & 52mm dia., non-cutting 4 SIZES IN ONE



60mmLONG SHANKS



85mmLONG SHANKS

60mmLONG SHANKS

- TI- BM-1098-38 38mm dia.

- TI- BM-1099-85 42mm dia. 85mmLONG SHANKS
- TI- BM-1100-38 38mm dia.

- TI- BM-1101-45 45mm dia.

Breast Markers



**"KEYHOLE" PATTERN
BREAST MARKERS TI- BM-1102-34** 34mm dia.

- TI- BM-1103-38 38mm dia.
- TI- BM-1104-42 42mm dia.
- TI- BM-1105-45 45mm dia.
- TI- BM-1106-50 50mm dia.

Calipers/Ruler



*Graduated 0-80mm
with locking screw JAMESON CALIPER* TI- BM-1107-00



*Graduated 0-80mm,
with locking screw*



CASTROVIEJO CALIPER TI- BM-1108-00

0-15mm scale CASTROVIEJO CALIPER TI- BM-1109-00

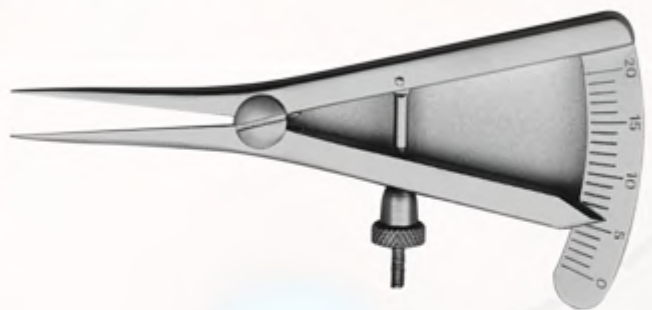

0-20mm scale



SURGICAL RULER

1-15cm in mm increments THORPE CALIPER
TI- BM-1110-00

McKISSOCK Keyhole Markers/Calipers
Length 5½" (14 cm)

	Size
TI-BM-111-14	38 mm
TI-BM-115-14	42 mm
TI-BM-116-14	45 mm
TI-BM-117-14	50 mm

PITANGUY Flap Grasping Forceps

	Length
TI-BM-118-14	5½" (14 cm)

D'ASSUMPCAO Face-Lift Markers
Length 6¼" (16 cm)

	Ratchet
TI-BM-1119-16	without ratchet
TI-BM-1120-16	with ratchet

PITANGUY Facial Demarcators

	Length
TI-BM-1121-16	6¼" (16 cm)
TI-BM-1122-255	10" (25.5 cm)



Markers & Rulers

Flap and Face lift Markers, Caliper

MARTEN Flap Markers

Length 5¾" (14.5 cm)

	Ratchet
TI-BM-1123-145	without ratchet
TI-BM-1124-145	with ratchet

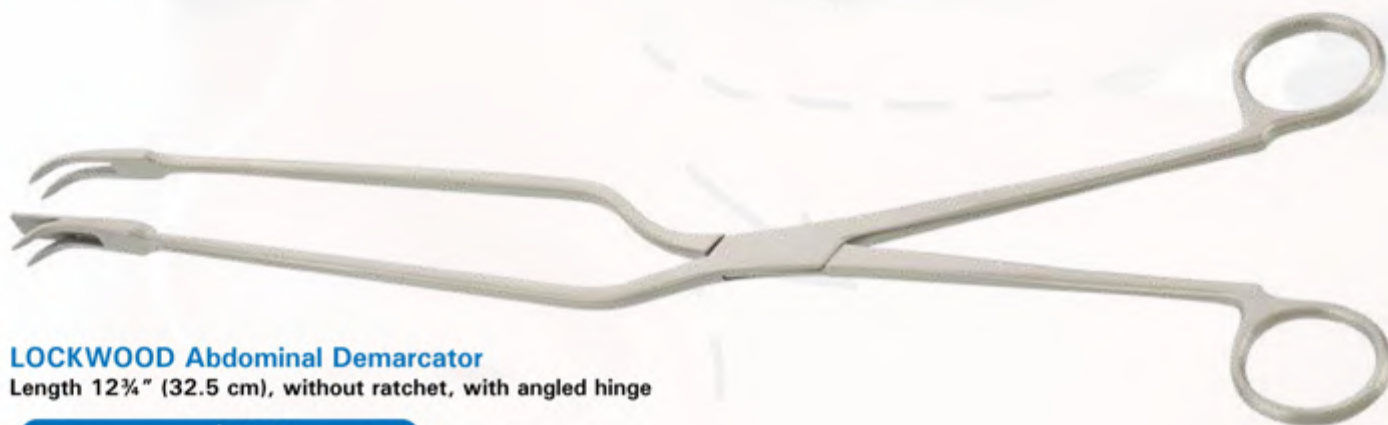

LOCKWOOD Abdominal Demarcator

Length 12¾" (32.5 cm), without ratchet, with angled hinge

	Width
TI-BM-1125-325	9.5 mm

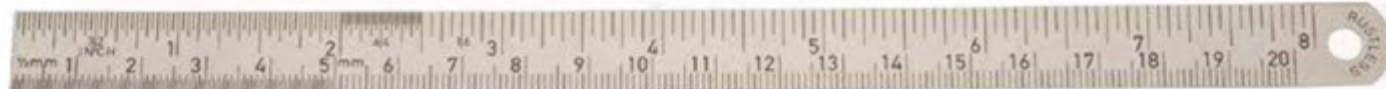

Metal Rulers

with inch and cm graduations

	Measuring range
TI-BM-1126-15	6" (15 cm)
TI-BM-1127-20	8" (20 cm)

McKISSOCK (COLLYER) Caliper

	Size
TI-BM-1128-30	12" (30 cm)



SHEEN Grid

with mm graduation, made from light weight aluminium

	Graduation
TI-BC-1129-00	70 x 40 mm

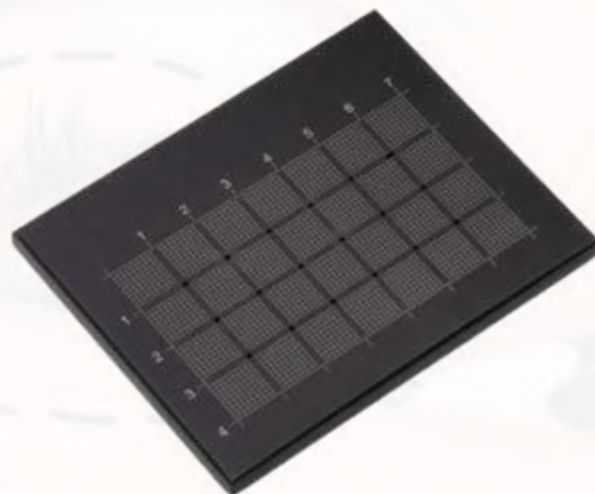

GRUBER Cartilage Cutting Block

	Size
TI-BC-1130-04	4" x 4" x 1/8"



HALPREN Breast Calipers

	Size
TI-BC-1131-34	34 mm
TI-BC-1132-38	38 mm
TI-BC-1133-42	42 mm



Calipers

JAMESON Calipers

Scale 0 - 80 mm

	Size
TI-BM-1134-95	3 ¼" (9.5cm)



THORPE (MARCHAC) Calipers

Scale 0 - 80 mm

	Size
TI-BM-1135-12	4 ¾" (12cm)



CASTROVIEJO Calipers

Scale 0 - 20 mm

	Size
TI-BM-1136-09	3 ½" (9 cm)



Fiber Optic LED

RUNS COOL
PRODUCES NO HEAT,
NO HEAT AT
INSTRUMENT END



true-color light source

THE UNIQUE "LIGHT" WEIGHT, COOL RUNNING FIBER OPTIC LED LIGHT SOURCE

Benefit from the latest LED-Technology - the new light source

combines operating efficiency with the highest demands on long-life performance. The 25W high intensive LED is comparable with a 100Watt Xenon Lamp and produces a true-color bright light.

Features:

- Runs Cool, No Heat generated by the LED Bulb
- A completely variable Rheostat controls Brightness
- LED true-color light source with 5,800°K light temperature
- 25W high intensity LED technology – equivalent to 100Watt Xenon light source
- Up to 50,000h lamp life
- Multi Port Light Cable Connector - Olympus, Storz, Wolf, ACMI
- World-wide power supply with active cooling
- 1.5 kg (3.3 lbs.) light weight design



FIBER OPTIC HEADLIGHTS

- Continuous fiber bundle with a diameter of 3.5mm produces a small and bright spot light
- Size and the direction of the spot light are adjustable
- The ergonomic headband with cross band can be adjusted easily with the use of only one hand
- The headband can be worn for several hours due to its ergonomic design and fit

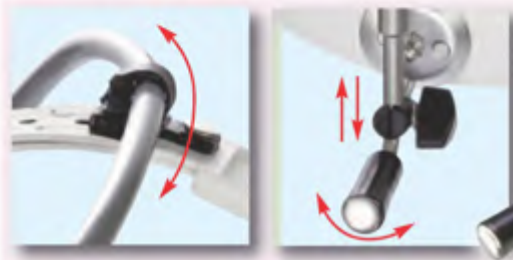

TI- FH-1137-00
Fiber Optic Headlight w/Cable,
3.5mm dia. F/O Cable, Dbl. Lens System
Adjustable Cushioned Headband

TI- FH-1138-00
LED Battery Headlight 3 Watt
with Li-ion Battery,
Headband w/Steples Regulation Wheel,
Transformer and Charger



TI- FH-1139-00
Fiber Optic Headlight w/110mm spot,
3.5mm Bifurcated F/O Cable
Adjustable Cushioned Headband



TI- FH-1140-00
Fiber Optic Headlight w/90° Cable,
3.5mm dia. F/O Cable, Dbl. Lens System
Adjustable Cushioned Headband

Please refer to the adapters shown on page 41 and include with your order of Fiber Optic Headlights.
NOTES: The headlight is not supplied with any adapter pieces necessary to connect it to the TI-FH-1141-00 light source.

Universal Fiber Optic Cables Our universal cables allow you to choose the

appropriate end-fitting adapters to match your light source and illuminated instrument end. The cables are reinforced with strain reliefs for maximum durability. ASSI.FOC158/6



- 3.5mm x 1800mm, 6ft, without adapters
TI- CA-1142-00
- 3.5mm x 2300mm, 7.5ft, without adapters
TI- CA-1143-00
- 3.5mm x 3000mm, 9.8ft, without adapters
TI- CA-1144-00
- 4.8mm x 1800mm, 6ft, without adapters
TI- CA-1145-00
- 4.8mm x 2300mm, 7.5ft, without adapters
TI- CA-1146-00
- 4.8mm x 3000mm, 9.8ft, without adapters

ADAPTERS

Cable to Light Source

- TI- CA-1147-00
Adapter for Wolf Light Source
- TI- CA-1148-00
Adapter for ACMI Light Source
- TI- CA-1149-00
Adapter for Storz Light Source
- TI- CA-1150-00
Adapter for Cuda Light Source
- TI- CA-1151-00
Adapter for Olympus Light Source
- TI- CA-1152-00
Adapter for Olympus GT10 Light Source
- TI- CA-1153-00
Adapter for Luxtec Light Source



Fiber Optic Light Guide

- TI- CA-1154-00
TI- CA-1155-00
TI- CA-1156-00
- Adapter for Wolf
Adapter for ACMI
Adapter for Storz/Olympus Type

Fiber Optic Head Light to Light Source

- TI- CA-1157-00
Adapter for Fiber Optic Headlight, Storz type



ENDOSCOPES FOR PLASTIC SURGERY

Ideal for procedures such as Face Lifts, Forehead Lifts, Breast Augmentation and Abdominoplasty

High quality German optics

Superior visualization in smaller pockets (4&5mm scope)
as well as in larger pockets (10mm scope)

The 30° lens angle allows for rotation of the scope,
increasing the field of vision without
repositioning the scope

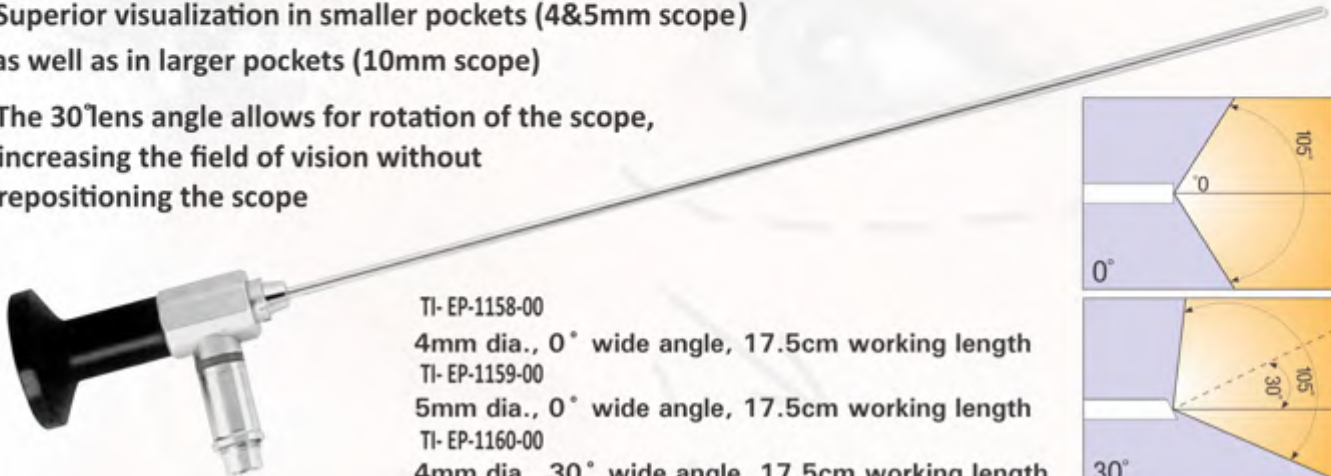

- TI-EP-1158-00
4mm dia., 0° wide angle, 17.5cm working length
- TI-EP-1159-00
5mm dia., 0° wide angle, 17.5cm working length
- TI-EP-1160-00
4mm dia., 30° wide angle, 17.5cm working length
- TI-EP-1161-00
5mm dia., 30° wide angle, 17.5cm working length

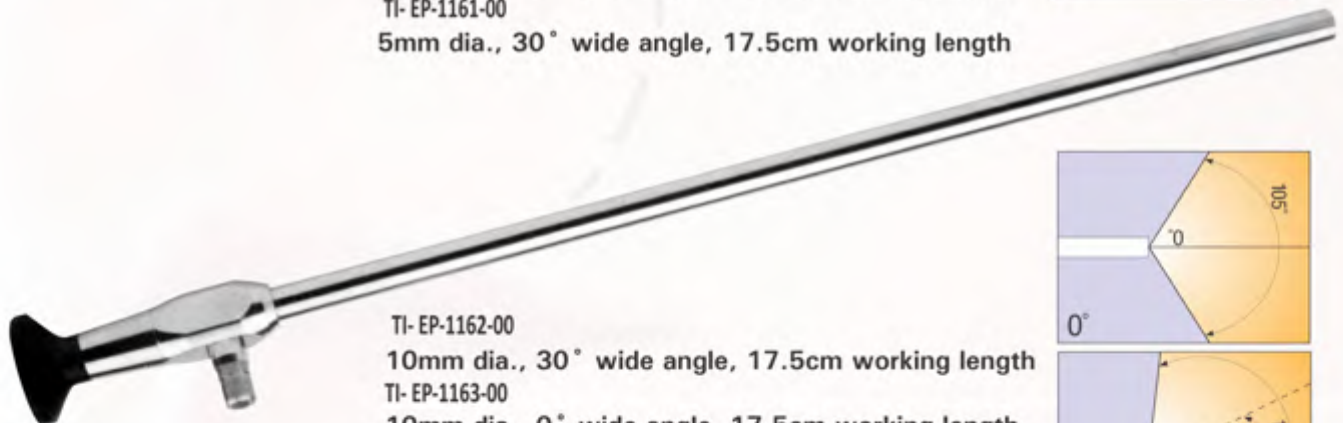

- TI-EP-1162-00
10mm dia., 30° wide angle, 17.5cm working length
- TI-EP-1163-00
10mm dia., 0° wide angle, 17.5cm working length
- TI-EP-1164-00
10mm dia., 30° wide angle, with Storz adapter,
17.5cm working length



- TI-EP-1165-00
See-Thru Medium Scope Case,
15.5 x 2.75 x 1.38 inch,
Holds 1 Scope 1-10mm Dia, Up to 15.5 inch long
- TI-EP-1166-00
See-Thru Large Scope Case,
18 x 2.75 x 1.38 inch,
Holds 1 Scope 1-10mm Dia, Up to 18 inch long

Universal Adapter for Breast Retractors



TI-RP-1167-00

Endoscopic Scope Sheath Support for:



TI-RP-1168-00
4mm Scope

TI-RP-1169-00
5mm Scope

TI-RP-1170-00
10mm Scope

O-Ring Set for Scope Sheath Support
(3 Rings Per Set - 2 Large and 1 Small)



TI-RP-1171-00
Fits 4mm and 5mm Scopes

TI-RP-1172-00
Fits 10mm Scope

Rotating Stop-Cock for Scope Sheath



TI-RP-1173-00
Fits 4mm and 5mm Scopes

FOX Dermal Curettes
Length 5½" (14 cm)



Fig./Spoon	Oval	Round
00 (1 mm)	TI-CU-1174-14	TI-CU-1180-14
0 (2 mm)	TI-CU-1175-14	TI-CU-1181-14
1 (3 mm)	TI-CU-1176-14	TI-CU-1182-14
2 (4 mm)	TI-CU-1177-14	TI-CU-1183-14
3 (5 mm)	TI-CU-1178-14	TI-CU-1184-14
4 (6 mm)	TI-CU-1179-14	TI-CU-1185-14

SCHAMBERG Comedon Extractors
Working Length 4" (10 cm)



medium, with crimp	TI-CU-1186-10
extra fine, with crimp	TI-CU-1187-10
delicate, with crimp	TI-CU-1188-10
heavy, with crimp	TI-CU-1189-10
delicate, without crimp	TI-CU-1190-10

UNNA Comedon Extractors
double ended oval, with hole



	Working Length
TI-CU-1191-145	5¾" (14.5 cm)

UNNA Comedon Extractors
double ended oval, with hole



	Working Length
TI-CU-1192-12	4¾" (12 cm)
TI-CU-1193-14	5½" (14 cm)

CONVERSE Curettes

Double ended, 6.5 x 8.5 mm / 7 x 10 mm



	Working Length
TI-CU-1194-21	8½" (21 cm)

WILLIGER Bone Spoon

Length 5¼" (13.5 cm), Oval, sharp, double ended



Fig.	
00/0	TI-CU-1195-135
0/1	TI-CU-1196-135
1/2	TI-CU-1197-135

MARTINI Bone Spoon

Length 5¼" (13.5 cm), round, sharp, double ended



Fig.	
00/0	TI-CU-1198-135
0/1	TI-CU-1199-135
1/2	TI-CU-1200-135



ROWE Zygomatic Bone Elevators

Length
10" (25.5 cm) TI-EL-1201-255

GORNEY Suction Elevators

4 mm Sharp Tip, with stylet

Length
7½" (19 cm) TI-EL-1202-19



FREER Elevators

double ended

Width	Length		
	7" (18 cm)	sharp/blunt	TI-EL-1203-18
5 mm	7½" (19.5 cm)	blunt/blunt	TI-EL-1204-195
6.5 mm	7½" (19.5 cm)	sharp/blunt	TI-EL-1205-195



COTTLE Septum Elevator

double ended, graduated

Length
9" (23 cm) TI-EL-1206-23



WOODSON Elevator

Length 7" (18 cm), double ended

4 x 10 mm, flat edge end	TI-EL-1207-18
2 x 11 mm, semi sharp tip	

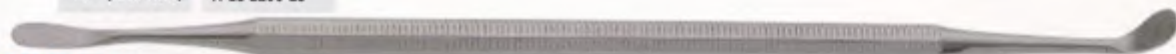

McCOLLOUGH Elevator

double ended

Length
TI-EL-1208-185 7¼" (18.5 cm)



MITCHELLS Trimmer/Elevator

knife blade & spoon shaped elevator

Length
TI-EL-1209-17 6¾" (17 cm)

WILLIGER Elevator

Length 6¾" (16 cm)

Tip	
4 mm	TI-EL-1210-00



Curettes, Chisels, Ostetomes Elevators, Knives

McKENTY Elevators

Length 6" (15 cm), sharp

Tip	Curved
4 mm	TI-EL-1211-15
5 mm	TI-EL-1212-15



JOSEPH Periosteal Elevator

Length 6 1/4" (16 cm)

Tip	
4 mm	TI-EL-1213-16



COTTLE Periosteal Elevator

Length	
7 1/2" (19 cm)	TI-EL-1214-19



OBWEGESSER Periosteal Elevators

Length 7" (17.5 cm)

Tip	
6 mm	TI-EL-1215-175
7 mm	TI-EL-1216-175
9 mm	TI-EL-1217-175
11 mm	TI-EL-1218-175



BOIES Elevator

Length	
7 3/4" (19.5 cm)	TI-EL-1219-195



BALLENGER Swivel Knives

Length 7 1/4" (20 cm)

Straight	Bayonet	Blade Width
TI-EL-1220-20	TI-EL-1220-20	3 mm
TI-EL-1221-20	TI-EL-1221-20	4 mm
TI-EL-1222-20	TI-EL-1222-20	5 mm
TI-EL-1223-20	TI-EL-1223-20	6 mm

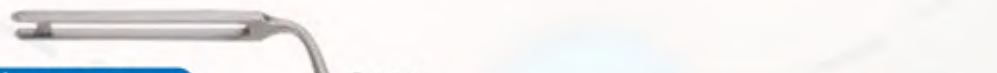

Bayonet

SILVER Rhinoplastic Chisels

Length 7" (18 cm)

Straight	TI-EL-1224-18
Right	TI-EL-1225-18
Left	TI-EL-1226-18



GUNTER Rhinoplastic Chisels

Length 8 ¼" (21 cm)



Straight	TI-CH-1227-21
Right	TI-CH-1228-21
Left	TI-CH-1229-21

NEIVERT Rhinoplastic Chisels

Length 8 ½" (21.5 cm)



Straight	TI-CH-1230-215
Right	TI-CH-1231-215
Left	TI-CH-1232-215

RISTOW Rhinoplastic Chisels

Length 8" (20.5 cm)



Right	TI-CH-1233-215
Left	TI-CH-1234-215

PARKES Lateral Osteotome

Length 7" (18 cm), 4mm tip, with guard



Straight	TI-OS-1235-18
----------	---------------

REES Osteotome

Length 8" (20.5 cm)



3 mm	TI-OS-1236-205
------	----------------

FREER Chisels

Length 6 ¼" (16 cm)



Straight	TI-CH-1237-16
Curved	TI-CH-1238-16

PARKES Gouge

Length 7" (18 cm)



6.5 mm	TI-CH-1239-18
--------	---------------

CONVERSE Osteotomes

Length 7" (18 cm)



Tip		Tip	
2 mm	TI-OS-1240-18	7 mm	TI-OS-1245-18
3 mm	TI-OS-1241-18	8 mm	TI-OS-1246-18
4 mm	TI-OS-1242-18	9 mm	TI-OS-1247-18
5 mm	TI-OS-1243-18	10 mm	TI-OS-1248-18
6 mm	TI-OS-1244-18	11 mm	TI-OS-1249-18

Curettes, Chisels, Osteotomes

Chisels, Osteotomes

SHEEN Radix Chisels

Length 7" (18 cm), 10 mm wide tip



Angle	TI-CH-1250-18
10°	TI-CH-1250-18
20°	TI-CH-1251-18

SHEEHAN Osteotomes

Length 6¼" (16 cm)



Tip	TI-OS-1252-16	Tip	TI-OS-1258-16
2 mm	TI-OS-1252-16	8 mm	TI-OS-1258-16
3 mm	TI-OS-1253-16	9 mm	TI-OS-1259-16
4 mm	TI-OS-1254-16	10 mm	TI-OS-1260-16
5 mm	TI-OS-1255-16	11 mm	TI-OS-1261-16
6 mm	TI-OS-1256-16	12 mm	TI-OS-1262-16
7 mm	TI-OS-1257-16	15 mm	TI-OS-1263-16

RUBIN Type Osteotomes

Length 7" (18 cm)



Tip	TI-OS-1264-18
6 mm	TI-OS-1264-18
8 mm	TI-OS-1265-18
10 mm	TI-OS-1266-18
11 mm	TI-OS-1267-18
12 mm	TI-OS-1268-18
14 mm	TI-OS-1269-18
16 mm	TI-OS-1270-18

CINELLI Chisels

Length 6¼" (16 cm), double guarded



Tip	TI-CH-1271-16
10 mm	TI-CH-1271-16
12 mm	TI-CH-1272-16
14 mm	TI-CH-1273-16
16 mm	TI-CH-1274-16

COTTLE Osteotomes

Length 7" (18 cm), graduated



Tip	TI-OS-1275-18	Tip	TI-OS-1279-18
2 mm	TI-OS-1275-18	8 mm	TI-OS-1279-18
4 mm	TI-OS-1276-18	9 mm	TI-OS-1280-18
6 mm	TI-OS-1277-18	10 mm	TI-OS-1281-18
7 mm	TI-OS-1278-18	12 mm	TI-OS-1282-18

LAMBOTTE Osteotomes

Length 6¼" (17 cm)

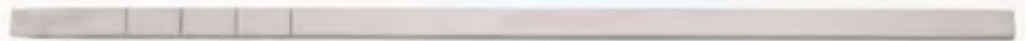

Tip	Straight	Curved
2 mm	TI-OS-1283-17	TI-OS-1287-17
3 mm	TI-OS-1284-17	TI-OS-1288-17
4 mm	TI-OS-1285-17	TI-OS-1289-17
6 mm	TI-OS-1286-17	TI-OS-1290-17



GERZOG Mallet

Head 225 g (8 oz.), Ø 1" (25 mm)

Length	
7" (18 cm)	TI-ME-1291-18



MEAD Mallet

Head dia. 26 mm, 320 g (11 1/4 oz.),
with plastic facings

Length	
TI-ME-1292-17	6 3/4" (17 cm) Spare nylon head



Mallet

Head dia. Ø 1" (25 mm), 250 g (8 7/8 oz.),
with plastic fiber handle

Length	
7" (18 cm)	TI-ME-1293-18

Mallet (Nylon / Steel)

Head dia. Ø 1" (25 mm), 265 g (9 3/8 oz.),
with one face steel and one face Nylon

Length	
TI-ME-1294-185	7 1/4" (18.5 cm)

(Not illustrated)

Bone Mallet

Head dia. Ø 3/4" (19 mm), 140 g (5 oz.)

Length	
6 1/2" (16.5 cm)	TI-ME-1296-165

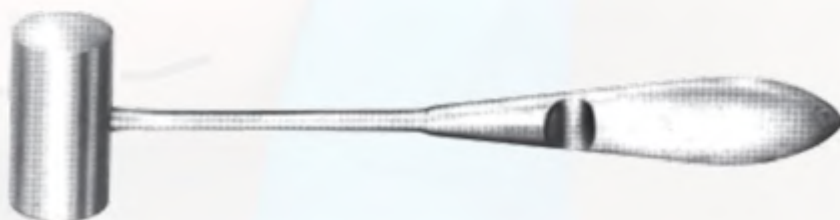

Mallets

Mallet (Nylon)

Head dia. Ø 1" (25 mm), 255 g (9 oz.),
with nylon heads

	Length
TI-ME-1297-185	7 ¼" (18.5 cm)
TI-ME-1298-185	Spare nylon head

Head dia. Ø 3/4" (19 mm), 218 g (7 5/8 oz.),
delicate, with nylon heads

	Length
TI-ME-1299-18	7" (18 cm)
TI-ME-1300-18	Spare nylon head



COTTLE (LUCAE) Mallet

Head dia. Ø 30 mm, 240 g, with 1 side flat and 1 side convex

Length		Head Diameter	Head Weight
7" (18 cm)	TI-ME-1301-18	Ø 1" (25 mm)	265g (9 3/8 oz.)
8" (20 cm)	TI-ME-1302-18	Ø 1-3/16" (30 mm)	200 g (7 3/4 oz.)

LUCAE Bone Mallet

Length 7 ½" (19 cm), Head dia. Ø 3/4" (19 mm)

230 g (8 oz.)	TI-ME-1303-18
260 g (9 oz.)	TI-ME-1304-18



KILLIAN Nasal Speculas
Length 5" (13 cm)



Fig.	Working Length		With Light Guide	With Fixation Scerw
1	35 mm	TI- NS-1305-13	TI- NS-1309-13	TI- NS-1313-13
2	50 mm	TI- NS-1306-13	TI- NS-1310-13	TI- NS-1314-13
3	75 mm	TI- NS-1307-13	TI- NS-1311-13	TI- NS-1315-13
4	90 mm	TI- NS-1308-13	TI- NS-1312-13	TI- NS-1316-13

COTTLE Nasal Speculas
Length 5" (13 cm)



	Working Length		With Fixation Scerw
	35 mm	TI- NS-1317-13	TI- NS-1321-13
	50 mm	TI- NS-1318-13	TI- NS-1322-13
	75 mm	TI- NS-1319-13	TI- NS-1323-13
	90 mm	TI- NS-1320-13	TI- NS-1324-13

VIENNA Nasal Speculas
Length 5½" (14 cm)



	Size	
	infant	TI- NS-1325-13
	child	TI- NS-1326-13
	adult	TI- NS-1327-13

DINGMANN Mouthgag

	Size
TI- NS-1328-00	Complete Set
TI- NS-1329-00	Blade Fig. 1 only
TI- NS-1330-00	Blade Fig. 2 only
TI- NS-1331-00	Blade Fig. 3 only
TI- NS-1332-00	Frame only



Ear, Nose, Throat

Septum Forceps, Nasal Cutting Forceps

SHEEN-KILLIAN Septum/Nasal Forceps

shaft 3 1/4" (82mm), flat serrated jaw 25 x 5.5 mm

Length
6 3/4" (17 cm) TI-NS-1329-17



WEIL-BLAKESLEY (WILDE) Nasal Cutting Forceps

Shaft length 4 3/4" (12 cm)

Tip	Straight
2.5 mm	TI-NS-1330-12
3.0 mm	TI-NS-1331-12
3.6 mm	TI-NS-1332-12
4.2 mm	TI-NS-1333-12
4.8 mm	TI-NS-1334-12

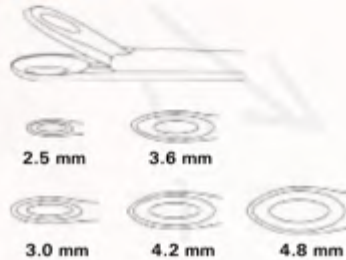

TAKAHASHI (WATSON-WILLIAMS) Nasal Cutting Forceps

Working length 4 3/4" (12 cm)

Tip	Straight
3 x 10 mm	TI-NS-1335-12



ASCH Septum Straightening Forceps

angled on flat

Length
9" (23 cm) TI-NS-1336-23



WALSHAM Septum Straightening Forceps

Length 9" (23 cm)

Straight	TI-NS-1337-23
Left	TI-NS-1338-23
Right	TI-NS-1339-23



GORNEY Scissors
Angled, Double Action

Standard	TC	Length
TI-NS-1340-23	TI-NS-1341-165 TI-NS-1342-205	6½" (16.5 cm) 8" (20.5 cm)



CAPLAN Scissors
Angled, Double Action

Standard	TC	Length
TI-NS-1343-21	TI-NS-1344-21	8¼" (21 cm)



GUNTER Morselizers
TC

Length	Serrated
7" (18 cm)	TI-NS-1345-18

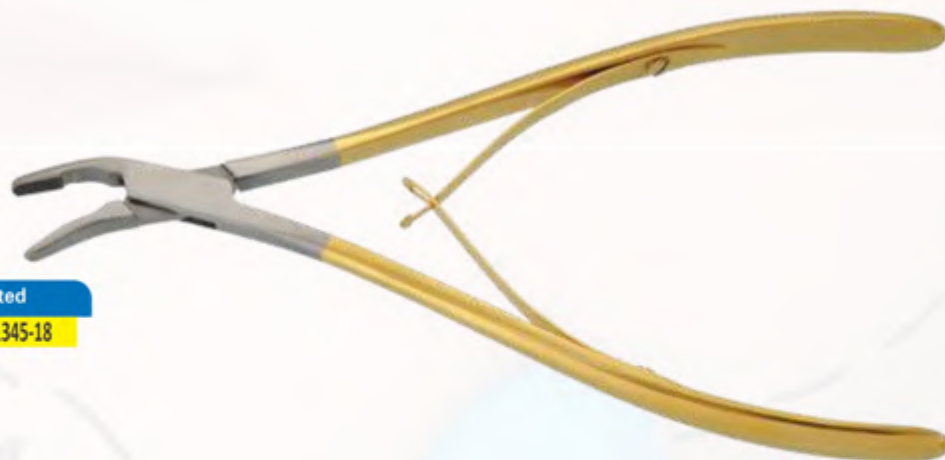

GORNEY Morselizers
Straight

Length
7¼" (18.5 cm) TI-NS-1346-185

(Not illustrated)

Ear, Nose, Throat
Cartilage Crushers, Nasal Cutting Forceps



RUBIN Septal Morselizers
Serrated angled shanks, with gaurd

Length	TC
8 1/4" (21 cm)	TI-NS-1348-21
	TI-NS-1349-21

JANSEN-MIDDLETON Nasal Cutting Forceps

Length
TI-NS-1350-195 7 3/4" (19.5cm)



GUBISCH (JOST) Crusher Morselizer

TI-NS-1351-00

(Not illustrated)

COTTLE Cartilage Crusher
With clip

smooth bed	TI-NS-1352-00
serrated bed	TI-NS-1353-00



TOLSDORF Cartilage Crusher
round

serrated bed	TI-NS-1354-00
smooth bed	TI-NS-1355-00





FOMON Nasal Rasps

Length 8" (20 cm), TC double sided

Fig.	Teeth	TC
1/2	12/14	TI-NR-1356-20
3/4	16/20	TI-NR-1357-20
5/6	24/30	TI-NR-1358-20
7/8	36/44	TI-NR-1359-20
9/10	52/62	TI-NR-1360-20

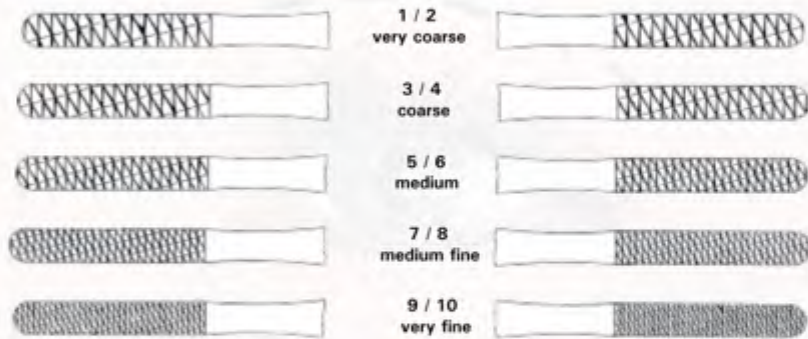

PARKES Nasal Rasps

Length 8 1/4" (21 cm), TC

Fig.	Teeth	TC Regular	
1	12	TI-NR-1361-21	very coarse
2	14	TI-NR-1362-21	very coarse
3	16	TI-NR-1363-21	coarse
4	20	TI-NR-1364-21	coarse
5	24	TI-NR-1365-21	medium
6	30	TI-NR-1366-21	medium
7	36	TI-NR-1367-21	fine medium
8	44	TI-NR-1368-21	fine
9	52	TI-NR-1369-21	very fine
10	62	TI-NR-1370-21	very fine



LEWIS Nasal Rasps

Length 7" (18 cm)

	Standard	TC
Fine teeth	TI-NR-1371-18	TI-NR-1373-18
Coarse teeth	TI-NR-1372-18	TI-NR-1374-18

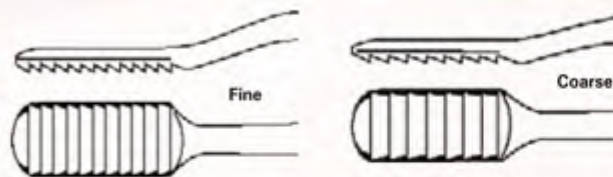

GLABELLA Nasal Rasps

TC	Length
TI-NR-1375-21	8 1/4" (21 cm)

MALTZ Nasal Rasps

Length 7" (18 cm), flat handle

Cutting	TC	
down/pull	TI-NR-1376-18	TI-NS-1378-18
up/push	TI-NR-1377-18	TI-NS-1379-18

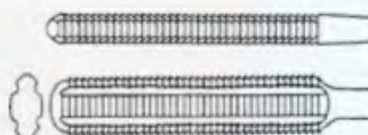

Ear, Nose, Throat

Nasal Rasps



FOMON Nasal Rasps

4 sided

TI-NR-1380-21	Length
	8 1/4" (21 cm)

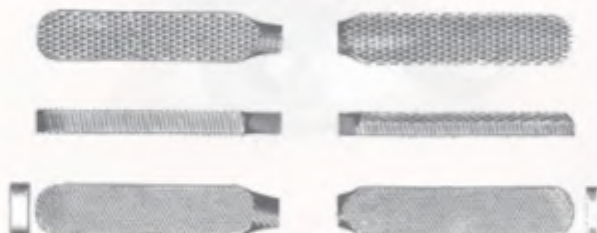

COTTLE (PARKES) Nasal Rasps

Downwards cutting

TI-NR-1381-21	Length
	8 1/4" (21 cm)



AUFRICHT Nasal Rasps

Length 8 1/2" (21.5 cm)

	Standard	Cutting
TI-NR-1382-215		Upwards
TI-NR-1383-215		Downwards

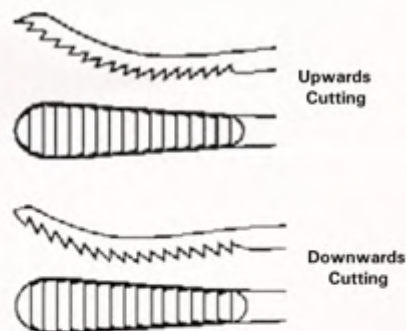

JOSEPH Nasal Rasps

medium teeth

TI-NR-1384-16	Length
	6 1/4" (16 cm)



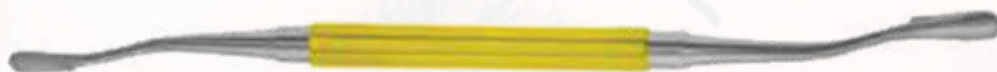

MILLER-COLBOURNE Bone Files

TC double sided Length 7" (18 cm), double sided

Fig.	Downwards	Cross Cutting
1	TI-NR-1385-18	TI-NR-1386-18

DINGMAN Otopraders

Length 6" (15 cm)

TI-NR-1387-15	Right
TI-NR-1388-15	Left
TI-NR-1389-15	Set (left + right)



Bone Instruments

Bone Rongeurs

BEYER Bone Rongeurs

3 mm Jaw

Length	Curved
7" (18cm)	TI-BR-1390-18
7" (18 cm)	TI-BR-1391-18



LEMPERT Bone Rongeurs

Length	Straight	Curved
8" (20 cm)	TI-BR-1392-20	TI-BR-1393-20

FRIEDMAN Bone Rongeurs

Length	Curved
5½" (14 cm)	TI-BR-1393-14



MINI-FRIEDMAN Bone Rongeurs

Length	Curved
4¾" (12 cm)	TI-BR-1394-12



CLEVELAND Bone Rongeurs

Length	Curved
5½" (14 cm)	TI-BR-1395-14



LISTON Bone Cutting Forceps

Length	Straight	Curved
5½" (14 cm)	TI-BR-1396-14	TI-BR-1398-14
6¾" (17 cm)	TI-BR-1397-17	TI-BR-1399-17



RUSKIN-LISTON Bone Cutting Forceps
Double action

Length	Straight	Curved
6" (15 cm)	TI-BR-1400-15	
7¼" (18.5 cm)	TI-BR-1401-185	

KLEINERT-KUTZ Bone Cutting Forceps

Length	Straight	Curved
5½" (14 cm)	TI-BR-1402-14	TI-BR-1403-14



Wire Instruments
Seizing Forceps, Wire Twister

CARROLL Tendon Seizing Forceps

	Working Length
TI-WI-1404-11	4 1/4" (11 cm)



CORWIN Automatic Wire Twisters

Length	Fig.	TC
6" (15 cm)	1	TI-WI-1405-11
6" (15cm)	2	TI-WI-1406-11
6 1/4" (16 cm)	3	TI-WI-1407-11
7" (18cm)	4	TI-WI-1408-11

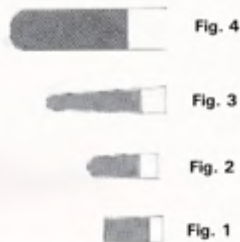

Wire Twisters
Length 6 1/4" (16 cm)

	Fig.	TC
long jaw		TI-WI-1409-16
flat jaw		TI-WI-1410-16
round jaw		TI-WI-1411-16

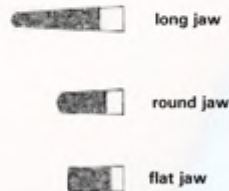
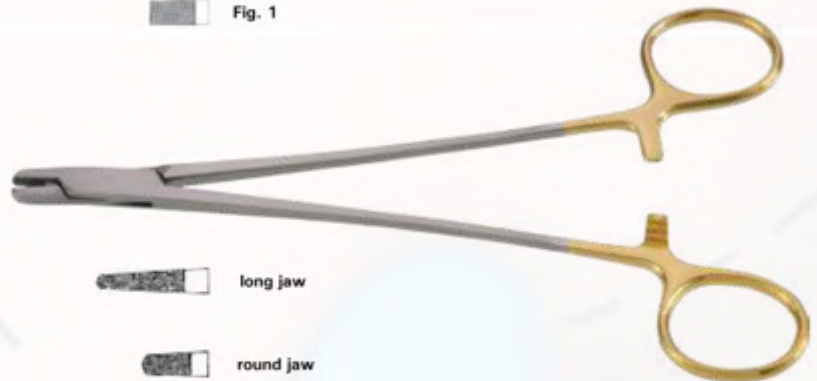

Wire & Pin Side Cutter
for hard wire upto 1.7 mm dia.

Length | TC
7" (18 cm) | TI-WI-1412-18



Wire & Pin Side Cutter
for hard wire upto 2.5 mm dia.

Length | TC
8 3/4" (22 cm) | TI-WI-1413-22



Wire & Pin Face and Side Cutter
for hard wire upto 1.7 mm dia.

Length | TC
7" (18 cm) | TI-WI-1414-18



Wire Instruments

Wire Pliers

Wire Seizing Forceps

Length 7" (18 cm), parallel grip, double action

Standard	TC	Tip
TI-WI-1415-18	TI-WI-1417-18	2.5 mm
TI-WI-1416-18	TI-WI-1418-18	5 mm



Wire Flat Pliers

face cutting, for 2.0 mm wire

Length	
6 3/4" (17 cm)	TI-WI-1419-17
6 3/4" (17 cm)	TI-WI-1420-17



Universal Flat Nose Pliers

Length	
8" (20 cm)	TI-WI-1421-20



Needle Nose Pliers

cross serrated

Length	
5 1/2" (14 cm)	TI-WI-1422-14



Operating Scissors

Length 5½" (14 cm)

Standard	TC	Tip	Shape
TI-SS-1423-14	TI-SS-1429-14	Blunt/Blunt	Straight
TI-SC-1424-14	TI-SC-1430-14	Blunt/Blunt	Curved
TI-SS-1425-14	TI-SS-1431-14	Sharp/Blunt	Straight
TI-SC-1426-14	TI-SC-1432-14	Sharp/Blunt	Curved
TI-SS-1427-14	TI-SS-1433-14	Sharp/Sharp	Straight
TI-SC-1428-14	TI-SC-1434-14	Sharp/Sharp	Curved



MAYO Dissecting Scissors

Standard	TC	SuperCut	Shape	Length
	TI-SS-1437-14		Straight	5½" (14 cm)
	TI-SC-1438-14		Curved	5½" (14 cm)
TI-SS-1435-17	TI-SS-1439-17	TI-SS-1441-17	Straight	6¾" (17 cm)
TI-SC-1436-17	TI-SC-1440-17	TI-SC-1442-17	Curved	6¾" (17 cm)



MAYO-NOBLE Dissecting Scissors

Length 6¾" (17 cm)

	TC	Shapes	Length
	TI-SS-1443-17	Straight	6¾" (17 cm)
	TI-SC-1444-17	Curved	6¾" (17 cm)



KILNER Dissecting Scissors

Curved

Standard	TC	SuperCut	Length
TI-SC-1445-13	TI-SC-1446-13	TI-SC-1447-13	5¼" (13 cm)



KELLY Scissors

Length 6¾" (16 cm)

Standard	TC	Shape
TI-SS-1448-16	TI-SS-1450-16	Straight
TI-SC-1449-16	TI-SC-1451-16	Curved



Scissors

Dissecting Scissors



METZENBAUM Dissecting Scissors

Standard	TC	TC SuperCut	Shape	Length
TI-SS-1452-145	TI-SS-1460-145	TI-SS-1468-145	Straight	5¾" (14.5 cm)
TI-SC-1453-145	TI-SC-1461-145	TI-SC-1469-145	Curved	5¾" (14.5 cm)
TI-SS-1454-18	TI-SS-1462-18	TI-SS-1470-18	Straight	7" (18 cm)
TI-SC-1455-18	TI-SC-1463-18	TI-SC-1471-18	Curved	7" (18 cm)
TI-SS-1456-205	TI-SS-1464-205	TI-SS-1472-205	Straight	8" (20.5 cm)
TI-SC-1457-205	TI-SC-1465-205	TI-SC-1473-205	Curved	8" (20.5 cm)
TI-SS-1458-23	TI-SS-1466-23	TI-SS-1474-23	Straight	9" (23 cm)
TI-SC-1459-23	TI-SC-1467-23	TI-SC-1475-23	Curved	9" (23 cm)

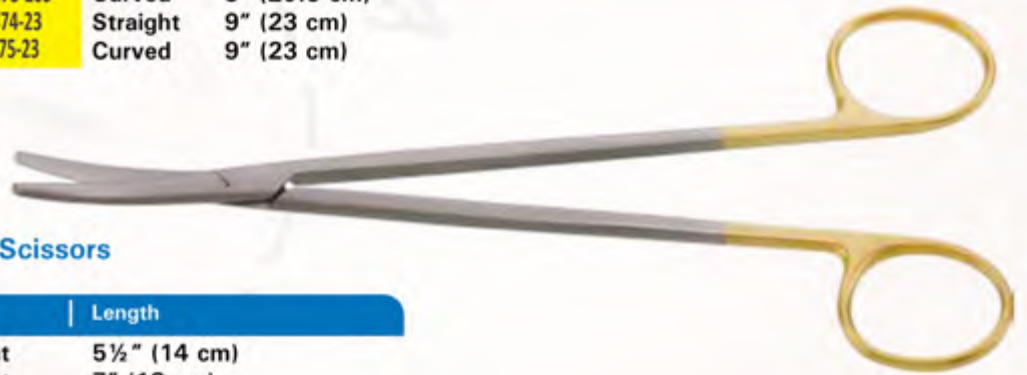

METZENBAUM Fino Dissecting Scissors

	TC	Shape	Length
	TI-SS-1476-14	Straight	5½" (14 cm)
	TI-SS-1477-18	Straight	7" (18 cm)
	TI-SC-1478-18	Curved	7" (18 cm)
	TI-SS-1479-20	Straight	8" (20 cm)
	TI-SC-1480-20	Curved	8" (20 cm)
	TI-SS-1481-23	Straight	9" (23 cm)
	TI-SC-1482-23	Curved	9" (23 cm)

BABY-METZENBAUM Dissecting Scissors

Length 4½" (11.5 cm)

Standard	Shape
TI-SS-1483-115	Straight
TI-SC-1484-115	Curved



LEXER-BABY Dissecting Scissors

Length 4" (10 cm)

Standard	Shape
TI-SC-1485-10	Curved



GORNEY Face-Lift Scissors

serrated blades

Standard	TC	TC SuperCut	Shape	Length
TI-SC-1486-14			Curved	5½" (14 cm)
TI-SS-1487-19	TI-SS-1489-19	TI-SS-1492-19	Straight	7½" (19 cm)
TI-SC-1488-19	TI-SC-1490-19	TI-SC-1493-19	Curved	7½" (19 cm)
	TI-SC-1491-23		Curved	9" (23 cm)

FREEMAN Face-Lift Scissors

Length 7" (18 cm), serrated blades

Standard	TC	Length
TI-SS-1494-18	TI-SS-1496-18	Straight
TI-SC-1495-18	TI-SC-1497-18	Curved

FREEMAN-GORNEY Face-Lift Scissors

Length 7" (18.5 cm), serrated blades

TC	TC SuperCut	Shape
TI-SS-1496-185	TI-SS-1498-185	Straight
TI-SC-1497-185	TI-SC-1499-185	Curved

KAYE-FREEMAN Face-Lift Scissors

Length 7" (18 cm), serrated blades, delicate

TC	SuperCut	Shape
TI-SS-1500-18	TI-SS-1502-18	Straight
TI-SC-1501-18	TI-SC-1503-18	Curved

KAYE Face-Lift Scissors

serrated blades, curved

Standard	TC	Shape
TI-SS-1504-115	TI-SS-1508-115	4½" (11.5 cm)
TI-SC-1505-145	TI-SC-1509-145	6" (14.5 cm)
TI-SS-1506-18	TI-SS-1510-18	7" (18 cm)
TI-SC-1507-23	TI-SC-1511-23	9" (23 cm)



Scissors

Rhytidectomy Scissors, Wire Scissors

REES Face-Lift Scissors

Serrated blades

TC	Shape	Length
TI-SS-1512-17	Straight	6 3/4" (17 cm)
TI-SC-1513-17	Curved	6 3/4" (17 cm)
TI-SS-1514-20	Straight	8" (20 cm)
TI-SC-1515-20	Curved	8" (20 cm)



ASTON Face-Lift Scissors

Serrated blades, curved

TC	Length
TI-SS-1516-17	6 3/4" (17 cm)
TI-SC-1517-20	8" (20 cm)



WILKINSON Face-Lift Scissors

Length 7 3/4" (19 cm), Duckbill tip

TC	Shape
TI-SC-1518-19	Curved



DAVIS Face-Lift Scissors

Length 7" (18 cm), serrated blades

TC	Shape
TI-SC-1519-18	Curved



CASTANARES Wire Scissors

Length 6 3/4" (16 cm)

TC	Shape
TI-SS-1520-16	Straight



FOMON Lower Lateral Scissors
strongly curved

Standard	Length
TI-SC-1521-14	5½" (14 cm)

FOMON Nasal / Dorsal Scissors
Length 5¾" (14.5 cm), one blade serrated

Standard	TC	Shape
TI-SC-1522-145	TI-SC-1523-145	Angled

COTTLE Nasal / Dorsal Scissors
Length 6¾" (17 cm), one blade serrated, Angled

Standard	TC	SuperCut
TI-SC-1524-17	TI-SC-1525-17	TI-SC-1526-17

KNIGHT Nasal Scissors
Serrated, Angled

TC	Length
TI-SS-1526-18	7" (18 cm)

JOSEPH Nasal Scissors
sharp/sharp

Standard	Shape	Length
TI-SS-1527-14	Straight	5½" (14 cm)
TI-SS-1528-14	Curved	5½" (14 cm)
TI-SS-1529-16	Straight	6¾" (16 cm)
TI-SC-1530-16	Curved	6¾" (16 cm)



Scissors

Tenotomy Scissors, Iris Scissors

REYNOLDS Tenotomy & Facelift Scissors

blunt/blunt

Standard	Shape	Length
TI-SS-1531-15	Straight	6" (15 cm)
TI-SS-1532-15	Curved	6" (15 cm)
TI-SS-1533-18	Curved	7" (18 cm)



STEVENS Tenotomy Scissors

Standard	TC	SuperCut	TC SuperCut	Shape	Tips	Length
TI-SS-1534-11	TI-SS-1542-11	TI-SS-1550-11	TI-SS-1558-11	Straight	Sharp/Sharp	4 1/4" (11 cm)
TI-SC-1535-11	TI-SC-1543-11	TI-SC-1551-11	TI-SC-1559-11	Curved	Sharp/Sharp	4 1/4" (11 cm)
TI-SS-1536-11	TI-SS-1544-11	TI-SS-1552-11	TI-SS-1560-11	Straight	Blunt/Blunt	4 1/4" (11 cm)
TI-SC-1537-11	TI-SC-1545-11	TI-SC-1553-11	TI-SC-1561-11	Curved	Blunt/Blunt	4 1/4" (11 cm)
TI-SS-1538-14	TI-SS-1546-14	TI-SS-1554-14	TI-SS-1562-14	Straight	Sharp/Sharp	5 1/2" (14 cm)
TI-SC-1539-14	TI-SC-1547-14	TI-SC-1555-14	TI-SC-1563-14	Curved	Sharp/Sharp	5 1/2" (14 cm)
TI-SS-1540-16	TI-SS-1548-16	TI-SS-1556-16	TI-SS-1564-16	Straight	Sharp/Sharp	6 1/4" (16 cm)
TI-SC-1541-16	TI-SC-1549-16	TI-SC-1557-16	TI-SC-1565-16	Curved	Sharp/Sharp	6 1/4" (16 cm)



IRIS Scissors

Sharp/Sharp

Standard	Shape	Length
TI-SS-1566-10	Straight	4 1/8" (10 cm)
TI-SS-1567-115	Straight	4 1/2" (11.5 cm)
TI-SC-1568-115	Curved	4 1/2" (11.5 cm)



IRIS Scissors

delicate, round shanks & screw joint, sharp/sharp

Standard	TC	SuperCut	Shape	Length
TI-SC-1570-115	TI-SC-1572-115	TI-SC-1574-115	Straight	4 1/2" (11.5 cm)
TI-SC-1571-115	TI-SC-1573-115	TI-SC-1575-115	Curved	4 1/2" (11.5 cm)



IRIS Ribbon Scissors

sharp/sharp

Standard	Shape	Length
TI-SS-1576-09	Straight	3 1/2" (9 cm)
TI-SC-1577-09	Curved	3 1/2" (9 cm)
TI-SS-1578-10	Straight	4" (10 cm)
TI-SC-1579-10	Curved	4" (10 cm)



STRABISMUS Scissors

Length 4½" (11.5 cm)

Standard	TC	SuperCut	Shape
TI-SS-1580-115	TI-SS-1582-115	TI-SS-1584-115	Straight
TI-SC-1581-115	TI-SC-1583-115	TI-SC-1585-115	Curved



SEALY Scissors

Length 4¾" (12 cm), General purpose scissors

Standard	Shape
TI-SS-1586-12	Straight
TI-SC-1587-12	Curved



SHEA Fine Scissors

delicate, curved, sharp

Standard	Length
TI-SC-1587-12	4¾" (12 cm)



KAYE Blepharoplasty Scissors

ribbon handle, serrated

Standard	Shape	Length
TI-SC-1588-115	Curved	4½" (11.5cm)



GRADLE Scissors

Length 4" (10 cm), sharp

Shape	Ribbon Handle
Straight	TI-SS-1589-10
Curved	TI-SC-1590-10

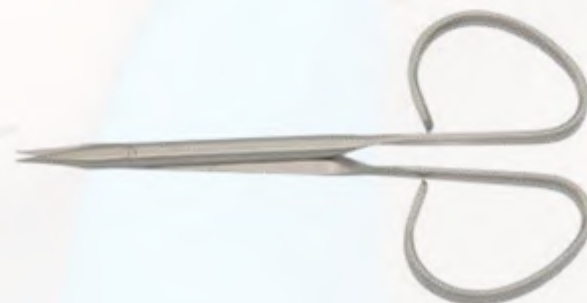

Scissors

Blepharoplasty, Dermal Naevus, Wire Scissors

Blepharoplasty Scissors

flat tips, one serrated blade

TC	Shape	Length
TI-SC-1590-115	Curved	4½" (11.5cm)



GUNTER (BIRO) Dermal Naevus Scissors

angled on flat, with sharp outside edges

	Length
TI-SC-1591-102	4" (10.2 cm)



GRADLE Scissors

Length 3¾" (9.5 cm), sharp

Standard	Shape
TI-SS-1592-095	Straight
TI-SC-1593-095	Curved



WILMER Conjunctival and Utility Scissors

Length, 4" (10.2 cm), Angled on flat, serrated cutting edge

TC	Standard	Tip
TI-SC-1593-102	TI-SC-1594-102	Sharp/Sharp



GREENBERG PAR Scissors

Length 4½" (11.5 cm)

TC	Shape
TI-SS-1595-115	Straight
TI-SC-1596-115	Curved



PAR Scissors

Length 4½" (11.5 cm)

TC	Shape
TI-SC-1597-115	Curved



GOLDMAN FOX Gum Scissors

Length 5" (13 cm)

TC	SuperCut	Shape
TI-SS-1598-13	TI-SS-1600-13	Straight
TI-SC-1599-13	TI-SC-1601-13	Curved



Universal Wire Scissors

one blade serrated

TC	Length
TI-SC-1602-12	4¾" (12 cm)



LITTLER Stitch Scissors

Length 5½" (14 cm), tip with eye for suture

Standard	Shape
TI-SC-1603-14	Curved



LITTAUER Stitch Scissors

Length 5½" (14 cm), one tip with hook for catching suture

Standard	Shape
TI-SS-1604-14	Straight



Scissors

Suture and Stitch Scissors, Bandage Scissors

SPENCER Stitch Scissors

Standard	Side Curved	Length
TI-SS-1605-09	TI-SC-1607-09	3½" (9 cm)
TI-SS-1606-09	TI-SC-1608-09	5" (12.7 cm)



O'BRIEN Stitch Scissors

fine angled tip, 15 mm cutting edge

Standard	Length
TI-SS-1609-10	4" (10 cm)
TI-SS-1610-12	4¾" (12 cm)



LISTER Bandage Scissors

angled

Standard	Length
TI-SS-1611-115	4½" (11.5 cm)
TI-SS-1612-14	5½" (14 cm)
TI-SS-1613-18	7¼" (18 cm)
TI-SS-1614-20	8¾" (20 cm)



KNOWLES Bandage Scissors

Length 5½" (14 cm)

Angled
TI-SS-1615-14



Utility scissors

Length 7" (18 cm)

Standard	Colors
TI-SS-1616-18	Black
TI-SS-1617-18	Blue
TI-SS-1618-18	Green
TI-SS-1619-18	Pink
TI-SS-1620-18	Red
TI-SS-1621-18	White
TI-SS-1622-18	Yellow





Micro Scissors, with round handle

Straight	Curved	Length
TI-SS-1623-15	TI-SC-1627-15	6" (15 cm)
TI-SS-1624-18	TI-SC-1628-18	7" (18 cm)
TI-SS-1625-18	TI-SC-1629-18	8 ¼" (21 cm)
TI-SS-1626-18	TI-SC-1630-18	9" (23 cm)

VANNAS Micro Scissors

Length 3" (7.6 cm), 5 mm blade

Straight	Curved
TI-SS-1631-076	TI-SC-1632-076



WESTCOTT Micro Scissors

Length 4 ¼" (11 cm), 10 mm blade

Straight	Curved	
TI-SS-1633-11	TI-SC-1634-11	Sharp / Sharp



WESTCOTT Stitch Scissors

Length 4 ¾" (12 cm), delicate blades

Straight	Curved	
TI-SS-1635-12	TI-SC-1636-12	Sharp / Sharp

CASTROVIEJO Micro Scissors

Length 4" (10 cm)

Curved	
TI-SC-1637-10	Sharp / Sharp
TI-SC-1638-10	Blunt / Blunt



Thumb & Tissue Forceps



Dressing Forceps

Serrated	1 x Teeth	Length
TI-TF-1639-115	TI-TF-1647-115	4½" (11.5cm)
TI-TF-1640-125	TI-TF-1648-125	5" (12.5cm)
TI-TF-1641-145	TI-TF-1649-145	5½" (14.5cm)
TI-TF-1642-16	TI-TF-1650-16	6¼" (16cm)
TI-TF-1643-18	TI-TF-1651-18	7" (18cm)
TI-TF-1644-20	TI-TF-1652-20	8" (20cm)
TI-TF-1645-255	TI-TF-1653-255	10" (25.5cm)
TI-TF-1646-30	TI-TF-1654-30	12" (30cm)

ADSON Dressing Forceps

Serrated tip

Serrated	1 x 2 Teeth	Length
TI-TF-1655-12	TI-TF-1657-12	4¾" (12cm)
TI-TF-1656-15	TI-TF-1658-15	6" (15cm)



ADSON Dressing Forceps

TC

Serrated	Smooth	1 x 2 Teeth	Length
TI-TF-1659-12	TI-TF-1661-12	TI-TF-1662-12	4¾" (12cm)
TI-TF-1660-15		TI-TF-1663-15	6" (15cm)



ADSON Micro Forceps

delicate

Serrated	1 x 2 Teeth	Length
TI-TF-1664-12	TI-TF-1665-12	4¾" (12cm)



ADSON Micro Dressing Forceps

Delicate, TC

Serrated	Smooth	Length
TI-TF-1666-12	TI-TF-1668-12	4¾" (12cm)
TI-TF-1667-12		6" (15cm)



HORTON ADSON Tissue Forceps

TC

	1 x 2 Teeth	Length
	TI-TF-1669-12	4¾" (12cm)
	TI-TF-1670-15	6" (15cm)



DANIEL-ADSON Forceps

spoon / cup shaped

	Length
TI-TF-1671-125	5" (12.5cm)
TI-TF-1672-15	6" (15cm)



ADSON-BROWN Tissue Forceps

7 x 7 Teeth

Straight	Angled to Side	7 x 7 Teeth	Length
TI-TF-1673-12	TI-TF-1675-12	TI-TF-1677-12	4 3/4" (12 cm)
TI-TF-1674-15	TI-TF-1676-15	TI-TF-1678-15	6" (15 cm)



ADSON Tissue Forceps

Length 4 3/4" (12 cm), with tying platform

Serrated	Tip
TI-TF-1679-12	
TI-TF-1680-12	1 x 2 Teeth
TI-TF-1681-12	Delicate
TI-TF-1682-12	1 x 2 Teeth, Delicate



GORNEY-ADSON Forceps

Length 4 3/4" (12 cm), TC

1 x 2 Teeth	Shapes
TI-TF-1683-12	diamond coated platform
TI-TF-1684-12	smooth platform



ADSON-DeBAKEY Atraumatic Tissue Forceps

Length 4 3/4" (12 cm)

Straight	Angled
TI-TF-1685-12	TI-TF-1686-12



PAR Forceps

TC	Length
TI-TF-1687-12	4 3/4" (12 cm)



ADSON Blepharoplasty Forceps

with delicate hooks

TC	Length
TI-TF-1688-12	5" (13 cm)

with standard hooks and platform

TC	Length
TI-TF-1689-13	5" (13 cm)



CASTROVIEJO Blepharoplasty Forceps

with extra fine hooks

TC	Length
TI-TF-1690-12	4 3/4" (12 cm)



Thumb & Tissue Forceps



SEMKEN Dressing Forceps

Serrated

Straight	1 x 2 Teeth	Length
TI-TF-1691-15	TI-TF-1692-15	6" (15 cm)
	TI-TF-1693-16	6 1/4" (16 cm)



TAYLOR Forceps

Length 7" (17.5 cm), with dissector end

Shapes	Straight	Bayonet
Serrated	TI-TF-1694-175 TI-TF-1695-175	1 x 2 teeth



POTTS-SMITH Dressing Forceps

	TC	Length
TI-TF-1696-18		7" (18 cm)
TI-TF-1697-20		8" (20 cm)
TI-TF-1698-25		9 1/4" (25 cm)



OEHLER Dressing Forceps

with TC platform

	1 x 2 Teeth	Length
TI-TF-1699-13		5" (13 cm)
TI-TF-1700-14		5 1/4" (14 cm)
TI-TF-1701-16		6 1/4" (16 cm)
TI-TF-1702-18		7" (18 cm)
TI-TF-1703-20		8" (20 cm)
TI-TF-1704-25		10" (25 cm)



GERALD Forceps

with TC platform, 1 x 2 teeth

Standard	Micro	Tip
TI-TF-1705-17	TI-TF-1706-17	6 3/4" (17 cm)



GILLIES Tissue Forceps

Serrated

	1 x 2 Teeth	Length
TI-TF-1707-15		6" (15 cm)

McINDOE Tissue Forceps
Serrated



1 x 2 Teeth	Length
TI-PF-1708-15	6" (15 cm)

CUSHING Forceps

Length 7" (18 cm), with TC platform



Straight	Angled	Bayonet
TI-PF-1709-18	TI-PF-1710-18	TI-PF-1711-18

JANSEN-GRUENWALD Nasal Polypus Forceps
Bayonet



Serrated	Length
TI-PF-1712-16	6 1/4" (16 cm)

LUCAE Ear Polypus Forceps
Length 5 1/2" (14 cm), Bayonet



Shape
TI-PF-1713-14 Serrated

TROELTSCH (WILDE) Ear Polypus Forceps



Angled	Length
TI-PF-1714-12	4 3/4" (12 cm)

DEBAKEY Atraumatic Tissue Forceps



Length	1.5 mm Tip	2 mm Tip	2.7 mm Tip	3.5 mm Tip
6" (15 cm)	TI-PF-1715-15	TI-PF-1720-15	TI-PF-1725-15	
6 1/4" (16 cm)	TI-PF-1716-16	TI-PF-1721-16	TI-PF-1726-16	TI-PF-1730-16
7 1/4" (19 cm)	TI-PF-1717-19	TI-PF-1722-19	TI-PF-1727-19	TI-PF-1731-19
9 1/2" (24 cm)	TI-PF-1718-24	TI-PF-1723-24	TI-PF-1728-24	TI-PF-1732-24
12" (30 cm)	TI-PF-1719-30	TI-PF-1724-30	TI-PF-1729-30	TI-PF-1733-30

Iris and Fine Forceps

GREEN Fixation Forceps

Length 4" (10.5 cm)

Tip Width	With lock	Without lock
5 mm	TI-IF-1734-105	TI-IF-1736-105
10 mm	TI-IF-1735-105	TI-IF-1737-105



CASTROVIEJO Forceps

Length 4 1/4" (10.5 cm), with platform, wide handle

Tip Width	1 x 2 Teeth
0.12 mm	TI-IF-1738-105
0.3 mm	TI-IF-1739-105
0.5 mm	TI-IF-1740-105
0.9 mm	TI-IF-1741-105
1.5 mm	TI-IF-1742-105



GRAEFE (CASTROVIEJO)-BROWN Forceps

with multiple teeth

Straight	Length
TI-IF-1743-115	4 3/4" (11.5 cm)



ADSON-GRAEFE Tissue Forceps

with multiple teeth

Straight	Length
TI-IF-1744-12	4 3/4" (12 cm)



GRAEFE Iris Forceps

Serrated	1 x 2 Teeth	Length
TI-IF-1745-10	TI-IF-1746-10	4" (10 cm)



BISHOP-HARMON Eye Forceps

Length 3 1/4" (8.5 cm)

	Tip Width
TI-IF-1747-085	0.8 mm, serrated
TI-IF-1748-085	0.8 mm, 1 x 2 teeth
TI-IF-1749-085	0.5 mm, fine serrated
TI-IF-1750-085	0.5 mm, fine 1 x 2 teeth



McPHERSON Suture Forceps

Length 4" (10 cm), with platform, 7 mm tip

Straight	Angled	Teeth
TI-IF-1751-10	TI-IF-1752-10 TI-IF-1753-10	1 x 2 Teeth



BONNEY Forceps

Length 6 3/4" (17 cm), with TC platform

TC	Tip
TI-IF-1754-17	1 x 2 teeth



Micro Dressing and Suture Forceps

Round handle, diamond coated jaws

	Shape	Tip	Length
TI-MF-1755-15	Straight	6.0 x 0.4 mm	6" (15 cm)
TI-MF-1756-18	Straight	6.0 x 0.4 mm	7" (18 cm)
TI-MF-1757-15	Curved	6.0 x 0.4 mm	6" (15 cm)
TI-MF-1758-18	Curved	6.0 x 0.4 mm	7" (18 cm)

Micro Vessel Dilating Forceps

Flat handle, popular in Hand Surgery

Length	Ø 0.2 mm	Ø 0.3 mm	Shape
4¼" (11 cm)	TI-MF-1759-11	TI-MF-1762-11	Straight
4¼" (11 cm)	TI-MF-1760-11	TI-MF-1763-11	10° Angled handle
7" (18 cm)	TI-MF-1761-18	TI-MF-1764-18	Straight



Micro Suture Tying Forceps

Round handle with guide pin, with platform

Length	Tip	Straight	Curved
4¾" (12 cm)	0.3 mm	TI-MF-1765-12	
6" (15 cm)	0.3 mm	TI-MF-1766-15	
7" (18 cm)	0.6 mm	TI-MF-1767-18	

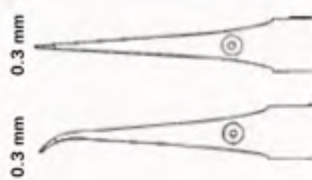

Jeweller's Forceps

	Fig	Tip	Length
TI-MF-1768-115	Fig. 1	4½" (11.5 cm)	straight, standard
TI-MF-1769-115	Fig. 3	4½" (11.5 cm)	straight, delicate
TI-MF-1770-105	Fig. 3C	4¼" (10.5 cm)	straight, delicate
TI-MF-1771-11	Fig. 4	4¼" (11.0 cm)	straight, very fine
TI-MF-1772-11	Fig. 5	4¼" (11.0 cm)	straight, ultra fine
TI-MF-1773-11	Fig. 5A	4¼" (11.0 cm)	angled, very fine
TI-MF-1774-11	Fig. 5/45°	4¼" (11.0 cm)	angled 45°, delicate
TI-MF-1775-11	Fig. 5/90°	4¼" (11.0 cm)	angled 90°, ultra fine
TI-MF-1776-11	Fig. 5/45°	4¼" (11.0 cm)	angled 45°, delicate
TI-MF-1777-11	Fig. 7	4¼" (11.0 cm)	curved, delicate

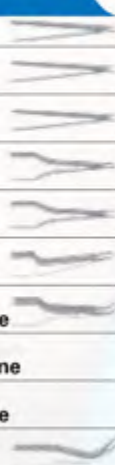

Forceps

Splinter Forceps, Cilia Forceps, Grasping Forceps

FEILCHENFELD Splinter Forceps

	Length
TI-MF-1778-115	4½" (11.5 cm)

Splinter Forceps

	Length
TI-MF-1779-10	4" (10 cm)

WALTER-CARMALT Splinter Forceps

Length 4¼" (10.5 cm)

	Serrated	Length
TI-MF-1780-105		straight
TI-MF-1781-105		angled tip

RALK Splinter Forceps

Length 6" (15 cm)

	Serrated	Length
TI-MF-1782-15		straight
TI-MF-1783-15		angled tip

LITTAUER Cilia Forceps

	Length	Tip
TI-MF-1784-085	3½" (8.5 cm)	flat smooth
TI-MF-1785-09	3½" (9 cm)	angled serrated

COTTLE Skin Grasping Forceps

with fixation screw

	Length
TI-MF-1786-11	4½" (11 cm)

DESMARRES Chalazion Clamp

Length 3½" (9 cm), with fixation screw

	Size	Tip
TI-MF-1787-09	small	11 x 17 mm
TI-MF-1788-09	medium	12 x 23 mm
TI-MF-1789-09	large	17 x 28 mm

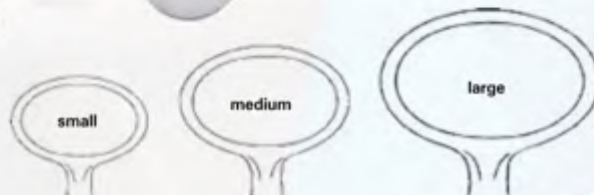
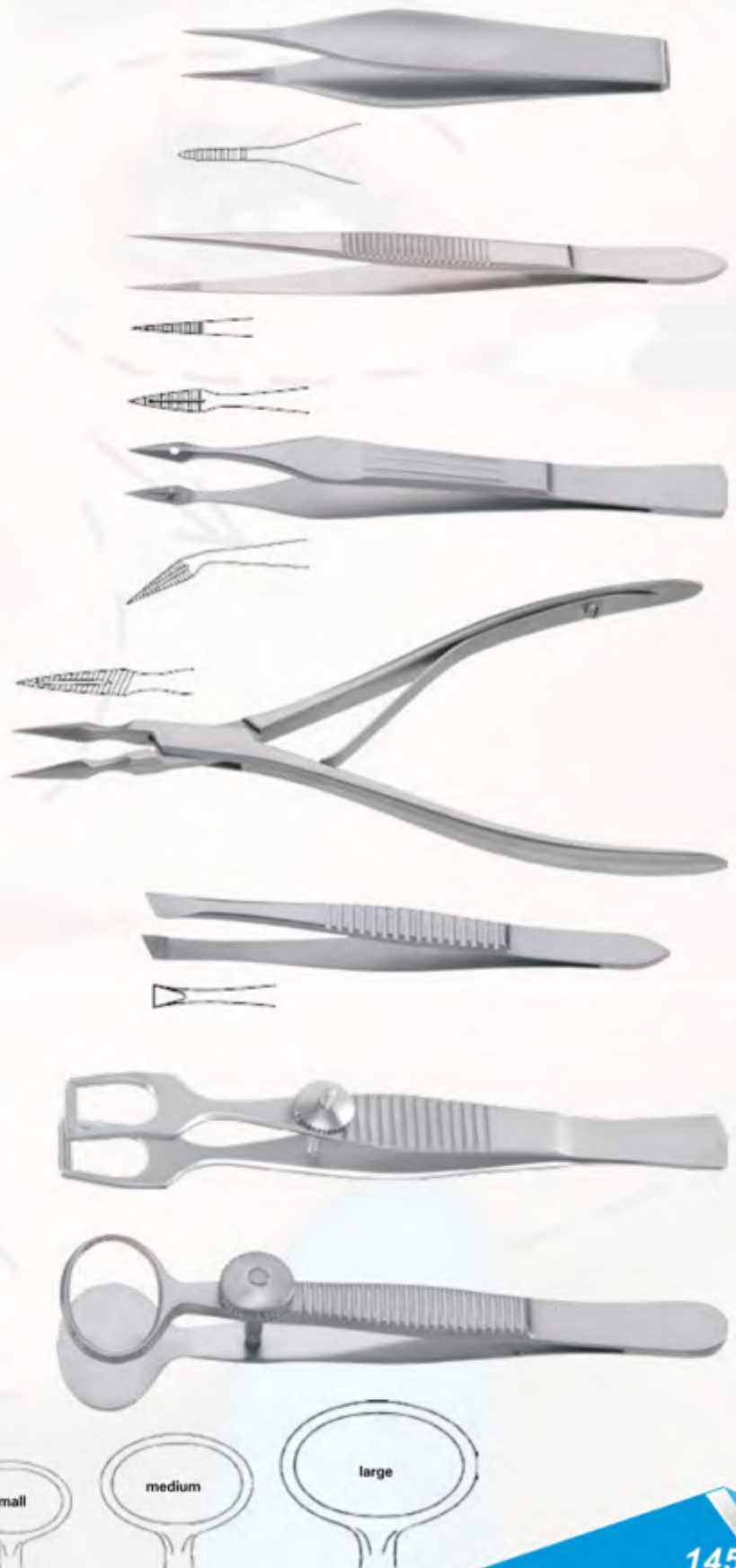

HARTMANN-MOSQUITO Hemostatic Forceps
Length 4" (10 cm)

	Straight	Curved
serrated	TI-MF-1790-10	TI-MF-1793-10
delicate	TI-MF-1791-10	TI-MF-1794-10
1 x 2 teeth	TI-MF-1792-10	TI-MF-1795-10



HALSTEAD-MOSQUITO Micro Hemostatic Forceps

Length	Straight	Curved
4 ¼" (12 cm)	TI-MF-1796-12	TI-MF-1798-12
5 ½" (14 cm)	TI-MF-1797-14	TI-MF-1799-14

Delicate

Length	Straight	Curved
5 ¼" (13.5 cm)	TI-MF-1800-135	TI-MF-1801-135



JULIAN MOSQUITO Forceps

Length	Curved
7 ½" (19 cm)	TI-MF-1803-19
9 ¼" (23.5 cm)	TI-MF-1804-235

(Not illustrated)

KELLY Hemostatic Forceps
Length 5 ½" (14 cm)

	Straight	Curved
half serrated	TI-MF-1805-14	TI-MF-1806-14



Hemostatic Forceps

CRILE Hemostatic Forceps

	Straight	Curved
5 1/2" (14 cm)	TI-MF-1807-14	TI-MF-1808-14



RANKIN-CRILE Hemostatic Forceps

Length 6 1/4" (16 cm)

	Straight	Curved
serrated	TI-MF-1816-16	TI-MF-1817-16



ROCHESTER-PEAN Hemostatic Forceps

serrated

	Straight	Curved
5 1/2" (14 cm)	TI-MF-1818-14	TI-MF-1821-14
6 1/4" (16 cm)	TI-MF-1819-16	TI-MF-1822-16
7" (18 cm)	TI-MF-1820-18	TI-MF-1823-18
8" (20 cm)	TI-MF-1821-20	TI-MF-1824-20



KOCHER (OCHSNER) Hemostatic Forceps

serrated, with 1 x 2 teeth

	Straight	Curved
5 1/2" (14 cm)	TI-MF-1825-14	TI-MF-1829-14
6 1/4" (16 cm)	TI-MF-1826-16	TI-MF-1830-16
7" (18 cm)	TI-MF-1827-18	TI-MF-1831-18
8" (20 cm)	TI-MF-1828-20	TI-MF-1832-20



ADSON Hemostatic Forceps
serrated

Length	Curved
7 1/4" (18.5 cm)	TI-MF-1833-185

MIXTER Hemostatic Forceps
Half serrated, strongly curved at right angle

Length	Right Angled
5 1/2" (14 cm)	TI-MF-1834-14
6" (15 cm)	TI-MF-1835-15
6 1/4" (16 cm)	TI-MF-1836-16
7 1/2" (19 cm)	TI-MF-1837-19
9" (23.5 cm)	TI-MF-1838-235

ALLIS-BABY Tissue Forceps

Length	4 : 5 Teeth
4 1/2" (12 cm)	TI-MF-1839-12

ALLIS Tissue Forceps
multiple teeth

Length	4 : 5 Teeth	5 : 6 Teeth
5" (13 cm)	TI-MF-1840-13	
5 1/2" (14.5 cm)	TI-MF-1841-145	
6" (15 cm)	TI-MF-1842-15	TI-MF-1843-15

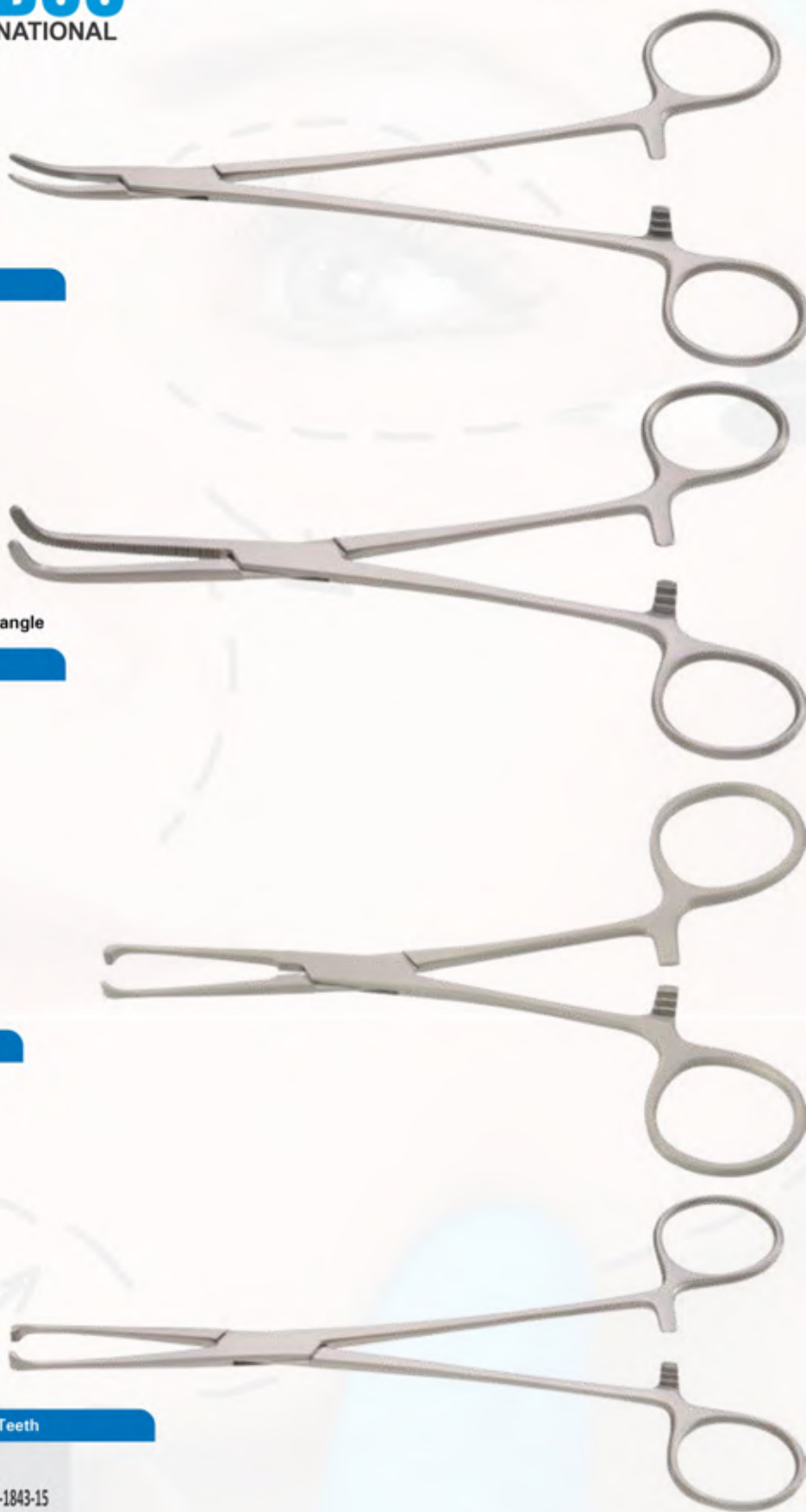

Hemostatic Forceps

Vulsellum Forceps, Towel Clamps

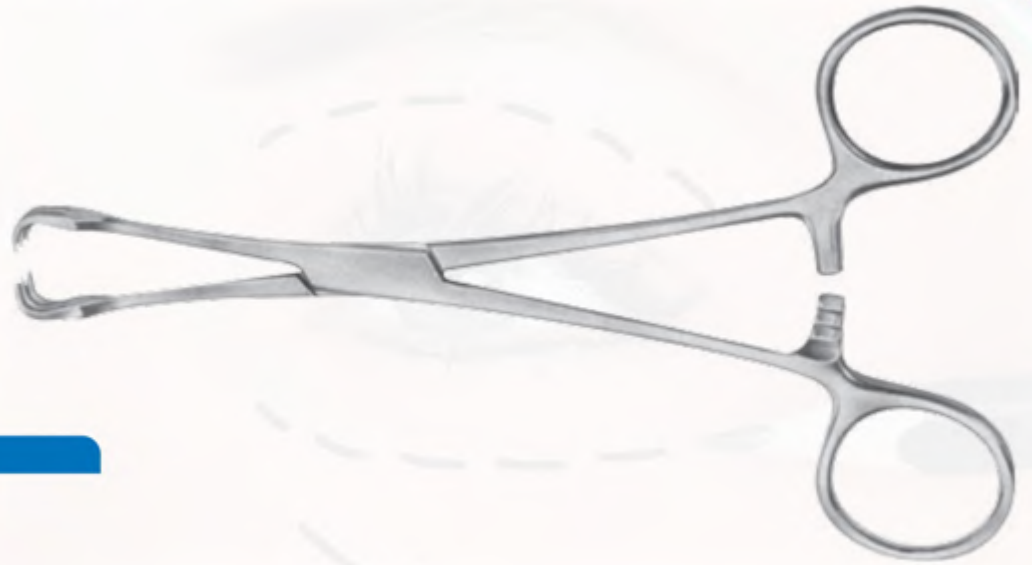

LAHEY Vulsellum Forceps

Sharp prongs

Length	3 x 3 Prongs
6" (15 cm)	TI-MF-1844-15

BACKHAUS Towel Clamps

Length	
3½" (9 cm)	TI-MF-1845-09
4¼" (11 cm)	TI-MF-1846-11
5¼" (13.5 cm)	TI-MF-1847-135



LORNA-EDNA Towel Clamp

Length	
4" (10 cm)	TI-MF-1848-10
5¼" (13.5 cm)	TI-MF-1849-135



JONES Towel Clamps

Length	
3½" (9 cm)	TI-MF-1850-09



FOERSTER Sponge Holding Forceps
Serrated jaw

Length	Straight	Curved
7" (18 cm)	TI-MF-1851-18	TI-MF-1853-18
9½" (24 cm)	TI-MF-1852-24	TI-MF-1854-24

USA MODEL Tubing Clamps
serrated

Length	With guard	Without guard
6" (15 cm)	TI-MF-1855-15	TI-MF-1857-15
7" (18 cm)	TI-MF-1856-18	TI-MF-1858-18



Needle Holders

DERF Needle Holders TC

Length	Serrated	Smooth	Serrated
4 3/4" (12 cm)	TI-NH-1859-12	TI-NH-1860-12	TI-NH-1861-12



WEBSTER (BABY) Needle Holders TC

Length	Serrated	Smooth	Serrated
4 3/4" (12 cm)	TI-NH-1862-12	TI-NH-1863-12	TI-NH-1864-12



WEBSTER Needle Holders TC

Length	Serrated	Smooth	Serrated	Smooth
5" (13 cm)	TI-NH-1864-13	TI-NH-1865-13	TI-NH-1866-13	TI-NH-1867-13



HALSEY Needle Holders TC

Length	Serrated	Smooth
5" (13 cm)	TI-NH-1868-13	TI-NH-1869-13



PAR Needle Holders

Extremely delicate Type

Length	TC
4½" (11.5 cm)	Ti-NH-1870-115
5" (13 cm)	Ti-NH-1871-13

NEIVERT (OFFSET) Needle Holder

with one offset ring

Length	TC
5" (13 cm)	Ti-NH-1872-13

BAUMGARTNER Needle Holders

Length	TC
5½" (14 cm)	Ti-NH-1873-14

CRILE WOOD Needle Holders

TC

Length	Serrated	Smooth
6" (15 cm)	Ti-NH-1874-15	Ti-NH-1878-15
7" (18 cm)	Ti-NH-1875-18	
8" (20 cm)	Ti-NH-1876-20	
9" (23 cm)	Ti-NH-1877-23	



Needle Holders

Vascular Needle Holders

MAYO HEGAR Needle Holders

TC

Length	TC	Standard
5½" (14 cm)		TI-NH-1882-14
6¼" (16 cm)	TI-NH-1879-16	TI-NH-1883-16
7" (18 cm)	TI-NH-1880-18	TI-NH-1884-18
8" (20 cm)	TI-NH-1881-20	TI-NH-1885-20

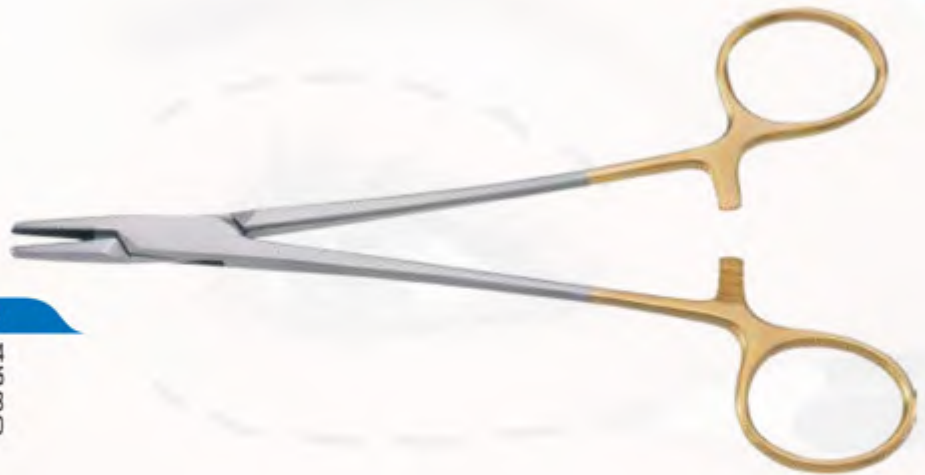

SWEDISH Needle Holder

TC

Length	TC
6¼" (15 cm)	TI-NH-1886-15



GILLIES Needle Holders

TC, Needle holder and scissors combination

Length	Serrated
4¼" (11 cm)	TI-NH-1887-11
5¼" (13 cm)	TI-NH-1888-13
6¼" (16 cm)	TI-NH-1889-16



OLSEN HEGAR Needle Holders

Needle holder & scissors combination, cut screw joint

Length	Serrated	Smooth	Left Handed	Cross Serrated	Smooth
4¼" (12 cm)	TI-NH-1890-12	TI-NH-1894-12	TI-NH-1896-12	TI-NH-1899-12	TI-NH-1903-13
5½" (14 cm)	TI-NH-1891-14	TI-NH-1895-14	TI-NH-1897-14	TI-NH-1900-14	TI-NH-1904-14
6¼" (16 cm)				TI-NH-1901-16	
6½" (16.5 cm)	TI-NH-1892-165		TI-NH-1898-165		
7" (18 cm)	TI-NH-1893-18		TI-NH-1889-18	TI-NH-1902-18	

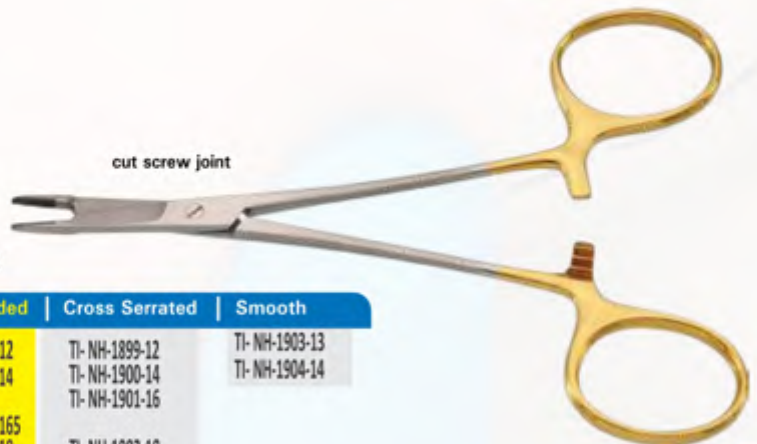

Micro Vascular Needle Holders
Serrated

Length	TC
6" (15 cm)	TI-NH-1905-15
7" (18 cm)	TI-NH-1906-18
8" (20 cm)	TI-NH-1907-20



EUPHRATE-PASQUE Needle Holders
extremely delicate, angled shanks

Length	TC
5½" (14 cm)	TI-NH-1908-14
6" (15 cm)	TI-NH-1909-15
7" (18 cm)	TI-NH-1910-18



LEMMON Needle Holders
TC

Length	TC
6¾" (17 cm)	TI-NH-1911-17



Needle Holders

Micro Needle Holders

CASTROVIEJO Micro Needle Holders

with lock, TC cross-serrated, flat handle

Straight	Curved	Length
TI-NH-1912-14 TI-NH-1913-17	TI-NH-1914-14 TI-NH-1915-17	5½" (14 cm) 7" (18 cm)

Length 5½" (14 cm), TC smooth, flat handle

With Lock	Shape
TI-NH-1916-14 TI-NH-1917-14	Straight Curved



CASTROVIEJO Micro Needle Holders

Length 5½" (14 cm), smooth jaws, flat handles

With Lock	Without Lock	Shape
TI-NH-1918-14 TI-NH-1919-14	TI-NH-1920-14 TI-NH-1921-14	Straight Curved



BARRAQUER Micro Needle Holders

Length 5" (13 cm), smooth jaws, round handles

With Lock	Without Lock	Shape
TI-NH-1922-13 TI-NH-1923-13	TI-NH-1924-13 TI-NH-1925-13	Straight Curved



Micro Needle Holders

without catch, smooth jaws, round handle

Straight	Curved	Length
TI-NH-1926-15	TI-NH-1927-15	6" (15 cm)



YANKAUER Suction Tubes

Length 11¼" (28.5 cm), with tube olive

Without Light Guide	With Light Guide	Central bore
TI-ST-1928-285	TI-ST-1929-285	Ø 2.0mm



FRAZIER (FERGUSON) Suction Tubes

Total Length 7" (18 cm), Working Length 4¼" (11 cm), 30° Angled, with finger cutoff and obturator

Without Light Guide	With Light Guide	Fig.
TI-ST-1930-18		4
TI-ST-1931-18		5
TI-ST-1932-18		6
TI-ST-1933-18		7
TI-ST-1934-18	TI-ST-1940-18	8
TI-ST-1935-18		9
TI-ST-1936-18	TI-ST-1941-18	10
TI-ST-1937-18		11
TI-ST-1938-18	TI-ST-1942-18	12
TI-ST-1939-18		14

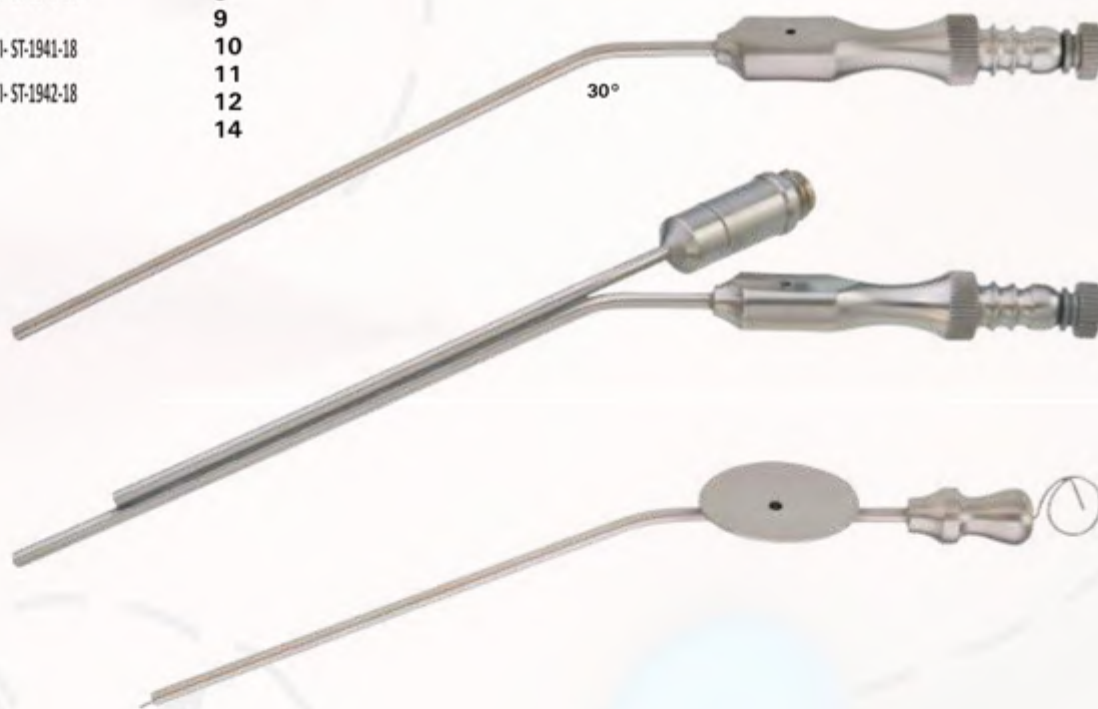

BARON (SCHUKNECHT) Suction Tubes

with finger cutoff and stylet

	Diameter
TI-ST-1943-00	Ø 1.0 mm (3 Fr.)
TI-ST-1944-00	Ø 1.7 mm (5 Fr.)
TI-ST-1945-00	Ø 2.3 mm (7 Fr.)

General Instruments
Scalpel Handles

Scalpel Handles
for blades 10 - 18 No.



Handle # 3	Length	Blades No.
TI-BP-1946-12	4¾" (12 cm)	10 - 18

with cm graduation



Handle # 3	Length	Blades No.
TI-BP-1947-12	4¾" (12 cm)	10 - 18



Handle # 3L	Length	Blades No.
TI-BP-1948-21	8¾" (21 cm)	10 - 18



Handle # 4	Length	Blades No.
TI-BP-1949-12	4¾" (12 cm)	20 - 25



Handle # 4L	Length	Blades No.
TI-BP-1950-21	8¾" (21 cm)	20 - 25



Handle # 7	Length	Blades No.
TI-BP-1951-165	6½" (16.5 cm)	10 - 18

Handle # 7K	Length	Blades No.
TI-BP-1952-125	5" (12.5 cm)	10 - 18

(Not illustrated)



SIEGEL Knife Handle, round

Handle # 7K	Length	Blades No.
TI-BP-1953-152	6" (15.2 cm)	10 - 18

BEAVER Handles
for micro scalpel blades



	Length
TI-BP-1954-10	4" (10 cm)
TI-BP-1955-125	5" (12.5 cm)
TI-BP-1956-15	6" (15 cm)

Scalpel handles, round



Straight	Angled	Blades / Length
TI-BP-1957-14	TI-BP-1959-14	10 - 18 / 5 1/2" (14 cm)
TI-BP-1958-16	TI-BP-1960-16	20 - 25 / 6 1/4" (16 cm)

Scalpel Handle, round
cm graduated



Handle # 3	Length	Blades No.
TI-BP-1961-145	5 3/4" (14.5 cm)	10 - 18

JOSEPH Button End Knife



	Length
TI-BP-1962-15	6" (15 cm)

FREER Mucosa end Knife



	Length
TI-FK-1963-15	6" (15 cm)

JOSEPH Nasal Saws
Length 7 1/2" (19 cm)



TI-NS-1964-19	Straight
TI-NS-1965-19	Left bayonet
TI-NS-1966-19	Right bayonet





WATSON Dermatome

Length 12" (30 cm), fixed bar, complete with blade

Right handed	Left handed	Spare blade
TI-DK-1967-30	TI-DK-1968-30	TI-DK-1969-30



HUMBY (BRAITHWAITE) Dermatome

Length 12" (30 cm), with oscillating bar, complete with blade

	Spare blade
TI-DK-1970-30	TI-DK-1971-30



SILVER Dermatome

Without blade, to be used with regular razor blades

	Length
TI-DK-1972-19	7 1/2" (19 cm)



Spare razor blades for SILVER dermatome

	Packing
TI-DK-1973-00	Pack of 10 Pcs



FOERSTER Capsulotomy Knife

	Length
TI-DK-1974-27	10 3/4" (27 cm)

Sponge Bowl
Stainless Steel

	Size
TI-BK-1975-115	11.5 cm x 5 cm / 4.5" x 2"
TI-BK-1976-145	14.5 cm x 5 cm / 5.75" x 2.5"



Solution Bowl
Stainless Steel

	Size
TI-BK-1977-165	16.5 cm x 7.5 cm / 6.5" x 3"
TI-BK-1978-19	19 cm x 7.5 cm / 7.5" x 3"
TI-BK-1979-245	24.5 cm x 10 cm / 9.75" x 4"
TI-BK-1980-325	32.5 cm x 13.5 cm / 12.75" x 5.25"



Emesis Kidney Basin

	Size
TI-BK-1981-15	15 cm x 9 cm x 4.5 cm (6" x 3.5" x 1.75")
TI-BK-1982-20	20 cm x 9.5 cm x 4.5 cm (8" x 3.6" x 1.75")
TI-BK-1983-255	25.5 cm x 11.5 cm x 5 cm (10" x 4.5" x 2")



Iodine Cup
Stainless Steel

	Size
TI-BK-1984-00	3.5" x 2" (6 oz)
TI-BK-1985-00	(14 oz)



Medicine Cup
Graduated

TI-BK-1986-00	(2 oz)
---------------	--------



Fiberoptic Light Guide Cables

- Flexible grey colored silicone-rubber sheathing
- Full length stainless steel sleaving around fiber bundle
- Stainless steel ends and adaptor
- Autoclavable / Steam Sterilizable

Other lengths, colors, fiber diameters and adaptors are available on demand.

Fiberoptic Light Guide Cables

Including Storz adaptor for light source instruments sides

Light Guide	Diameter	Length
TI-FL-1987-183	Ø 3.5 mm	6 feet (183 cm)
TI-FL-1988-229	Ø 3.5 mm	7.5 feet (229 cm)
TI-FL-1989-183	Ø 5.0 mm	6 feet (183 cm)
TI-FL-1990-229	Ø 5.0 mm	7.5 feet (229 cm)
TI-FL-1991-305	Ø 5.0 mm	10 feet (305 cm)

Without adaptors

Light Guide	Diameter	Length
TI-FL-1992-183	Ø 3.5 mm	6 feet (183 cm)
TI-FL-1993-229	Ø 3.5 mm	7.5 feet (229 cm)
TI-FL-1994-183	Ø 5.0 mm	6 feet (183 cm)
TI-FL-1995-229	Ø 5.0 mm	7.5 feet (229 cm)



Light Source Side Adapter

Adapters	Manufacturer
TI-FL-1996-00	Olympus
TI-FL-1997-00	Storz
TI-FL-1998-00	ACMI/British Standard
TI-FL-1999-00	Wolf



TI-FL-1996-00



TI-FL-1997-00



TI-FL-1998-00



TI-FL-1999-00



TI-FL-2000-00



TI-FL-2001-00



TI-FL-2002-00

Instrument/Endoscope Side Adapter

Adapters	Manufacturer
TI-FL-2000-00	Wolf
TI-FL-2001-00	ACMI/British Standard
TI-FL-2002-00	Storz

Description

Surgical and dental instruments are designed to perform specific functions such as cutting, grasping, clamping, dissecting, probing, retracting, draining, aspirating, suturing, or ligating. Surgical instruments may also be used to facilitate the insertion of surgical implants.

Contraindication

Instruments should not be used for anything other than their intended use.

Warning

Devices shall be used in accordance with these instructions for use. Read all sections of this insert prior to use. Improper use of this device may cause serious injury. In addition, improper care and maintenance of the device may render the device non-sterile prior to patient use and cause a serious injury to the patient or health care provider.

Caution

Surgivalley's instruments are supplied non-sterile, unless otherwise noted and must be cleaned, lubricated (if required) and sterilized prior to use according to hospital protocol and procedures outlined in this document.

- Inappropriate use of instruments may result in patient injury, damaged or broken instruments.
- Proper cleaning, handling, sterilization and standard routine maintenance (such as sharpening, lubrication if applicable) will ensure that the instruments perform as intended and will extend their useful life.
- Delicate surgical/dental instruments require special handling to prevent damaging the tips. Use caution during cleaning and sterilization.
- Do not expose instruments to phenols or iodophors.
- Do not use dry heat sterilization for aluminum or plastic made, black coated or ebonized instruments.
- Do not apply excessive stress or strain at joints; misuse will result in misalignment or cracks at the box locks or jaws.
- Rongeurs and bone cutting forceps should only be used to cut bone, never wire or pin. Do not twist or apply excessive stress during use.
- Wear appropriate protective gloves, eyewear and clothing when handling biologically contaminated instruments.
- Instruments manufactured from different metals or with special coating, should be processed separately to avoid electrolytic action between the different metals.
- Before use, inspect the instruments for possible damage, wear or non-functioning parts. Carefully inspect the critical, inaccessible areas, joints and all movable parts.
- Damaged or defective instruments should not be used or processed.

Care And Handling

1. Pre-cleaning:

- Keep instruments moist and do not allow blood and/or bodily fluids to dry on the instruments.
- Remove gross contaminants with steady stream of lukewarm/cool water (below 110°F/43°C). Rinse each instrument thoroughly. Do not use saline or chlorinated solutions.

Open jaws of hinged instruments for cleaning. Give special attention to joints and serrations. Instruments having more than one part or piece must be disassembled (if possible) to expose all surfaces to the cleaning process. Retain all parts to facilitate reassembly.

- Separate sharp and delicate surgical instruments. Avoid processing instruments of different metallic composition together.
- Keep ebonized instruments separate from other stainless steel instruments to avoid scratches to and removal of the ebonized coating.

2. Rinse: Rinse instruments thoroughly under warm distilled or demineralized water.

3. Cleaning:

Cleaning Precautions:

- If appropriate, disassemble surgical instruments prior to cleaning and sterilization.
- Do not soak instruments in hot water, alcohol, disinfectants or antiseptics to avoid coagulation of mucus, blood or other body fluids. Do not exceed two hours soaking in any solution.
- Do not use steel wool, wire brushes, pipe cleaners or abrasive detergents to remove soil as these will damage the instrument and lead to corrosion.
- Microsurgical, plated and delicate instruments should be cleaned manually and should not be processed in an ultrasonic cleaner. Carefully protect the tips of delicate microsurgical instruments throughout the entire cleaning and sterilization process.
- To preserve the surface coating of ebonized instruments, keep ebonized instruments separate from other instruments and avoid mechanical cleaning and abrasive cleaners as these processes can scratch the surface and remove the surface coating.
- Color anodized aluminum instruments may lose their color through the use of conventional, mechanical treatment processes.

A. Manual Cleaning: To prevent formation of biofilm, cleaning should occur as soon as possible after instrumentation is used.

- Choose a cleaning solution appropriate for surgical/dental instruments and follow manufacturer's instructions for use.
- The use of neutral pH detergents is recommended to avoid corrosion, pitting and breakage.
- Using a small, clean hand-held brush, remove soil from all surfaces of instrument while fully immersed in solution

B. Ultrasonic And Mechanical Cleaning

- For ultrasonic cleaning, follow manufacturer's specifications for water level, concentration levels of cleaning agent and temperature.
- Use an ultrasonic cleaner to remove soil from hard to reach surfaces such as grooves, crevices and moving parts after gross soil has been removed.
- Open or disassemble instruments as appropriate.
- When using mechanical washer, make sure all instruments stay properly in place and do not touch or overlap each other.
- Do not allow ebonized instruments to come in contact with each other or other instruments.
- Always follow the manufacturer's specifications for automatic washer-sterilizers and use a free-rinsing, low-sudsing detergent with a neutral pH (6.0 - 8.5). Due to variations in water quality, the type of detergent and its concentration may require adjustment for optimal cleaning.

4. Rinse And Dry: Rinse all instruments thoroughly with distilled, pyrogen-free water to remove all traces of debris and cleansing agents. Make sure all internal lumens and ratchets are thoroughly rinsed. Instruments must be thoroughly dried and all residual moisture must be removed before they are stored. Use a soft, absorbent towel/cloth to dry external surfaces. Compressed air may be used to aid the drying process.

5. Lubricate: The use of a water soluble instrument lubricant that is compatible with the method of sterilization to be used is recommended before instruments are sterilized.

After thoroughly cleaning the instruments, proper application of lubricants to all joints and movable mating surfaces will keep them moving freely and aid in protecting surface from mineral deposits.

- Proper lubrication is required for all instruments, regardless of surface coatings.
- Note that ultrasonic cleaners remove all lubrication; therefore, this maintenance procedure should be done routinely after ultrasonic cleaning and before sterilization.
- If following the lubricating procedure, do not rinse after this step.

6. Sterilization:

All devices must be processed in the completely open position (i.e. flushports, jaws, etc.) to allow sterilant contact of all surfaces.

All devices with concave surfaces shall be configured so that water pooling does not occur.

Sterilization Method	Temperature	Exposure Time	Dry Time
High Vacuum Steam (Pre-vacuum)			
Wrapped	270°F (132°C)	3 minutes minimum	N/A

High Vacuum Steam (Pre-vacuum)			
Unwrapped in containers	270°F (132°C)	4 minutes minimum	20 minutes
Perforated stacked/unstacked			
Solid unstacked			

Gravity Steam			
Unwrapped in containers	250°F (121°C)	45 minutes	20 minutes
Perforated unstacked			

Gravity Steam			
Wrapped in cassettes	250°F (121°C)	30 minutes	20 minutes

Ethylene Oxide (EtO)			
Unwrapped in containers	131°F (55°C)	60 minutes (minimum)	Concentration: 725 mg/l
Perforated unstacked			
Solid unstacked			
		Humidity: 70%	
		Aeration time: 8 hours minimum	

7. Storage

After sterilization, devices must remain in sterilization packaging and be stored in a clean, dry environment.

Returned Goods Policy

1. Goods will be accepted for return for the following reasons and must be accompanied by a RGA.
 - A. If shipment was made without Customer's authorization;
 - B. If incorrect items were shipped;
 - C. If defective items were shipped;
 - D. If defective goods are covered by the standard warranty;
 - E. If the goods were sent on evaluation basis.
2. To return goods, contact a Customer Service Representative by telephone for an RGA (Returned Goods Authorization) number. The RGA # must also be clearly indicated on the outside of the returned package. Please have the following information:
 - A. Reason you wish to return the goods;
 - B. Quantity, description, product number;
 - C. Date of Receipt of Order;
 - D. Customer's Purchase Order and the Carnegie Surgical invoice number;
 - E. All instruments that have been used must be cleaned and sterilized prior to shipment.
3. Shipment must be returned prepaid by Customer. Freight collect shipments will not be accepted.
4. If Customer intends to return equipment ordered in error, the following restocking charges and terms will apply:
 - A. 25% within 90 days from date of shipment;
 - B. Goods must be returned unused, in the original carton, and in marketable condition;
 - C. Refurbishing and replacement charges will be added to the restocking charges for damaged or missing items;
 - D. No return after 90 days;
 - E. No refund on sterile, single-use disposable products.
 - F. No refund will be made on customized instruments.

Warranty

Surgivalley Pvt Ltd stainless steel instruments are warranted for a period of two (2) years from the original date of purchase. Our single patient use products are warranted for 90 days against defects in work-manship or materials that are discovered prior to initial use or expiration. If instruments should fail as the result of a defect in materials or workmanship, Surgivalley is committed to take steps it believes are necessary to rectify the problem. These steps may include, but are not limited to, repair, replacement or supplying an alternative instrument. This warranty does not cover general maintenance such as cleaning and sharpening services required as a result of normal use. It does not include damage that is caused by misuse, improper care, the use of improper chemicals or cleaning methods, negligence, modification or unauthorized service by non-Surgivalley personnel, or normal wear. Damage to insulating coatings on electro-surgical instruments is excluded from the terms of this warranty.

The sole remedy under this warranty shall be repair or replacement as provided above at the sole discretion of Surgivalley Instruments. In no event will Surgivalley be liable for any damages arising out of loss of use, or any other incidental or consequential damages. The foregoing limited warranty is in lieu of any other warranty with respect to Surgivalley products. Surgivalley grants no other warranty, express or implied

Returned Goods Policy

1. Goods will be accepted for return for the following reasons and must be accompanied by a RGA.
 - A. If shipment was made without Customer's authorization;
 - B. If incorrect items were shipped;
 - C. If defective items were shipped;
 - D. If defective goods are covered by the standard warranty;
 - E. If the goods were sent on evaluation basis.
2. To return goods, contact a Customer Service Representative by telephone for an RGA (Returned Goods Authorization) number. The RGA # must also be clearly indicated on the outside of the returned package. Please have the following information:
 - A. Reason you wish to return the goods;
 - B. Quantity, description, product number;
 - C. Date of Receipt of Order;
 - D. Customer's Purchase Order and the Carnegie Surgical invoice number;
 - E. All instruments that have been used must be cleaned and sterilized prior to shipment.
3. Shipment must be returned prepaid by Customer. Freight collect shipments will not be accepted.
4. If Customer intends to return equipment ordered in error, the following restocking charges and terms will apply:
 - A. 25% within 90 days from date of shipment;
 - B. Goods must be returned unused, in the original carton, and in marketable condition;
 - C. Refurbishing and replacement charges will be added to the restocking charges for damaged or missing items;
 - D. No return after 90 days;
 - E. No refund on sterile, single-use disposable products.
 - F. No refund will be made on customized instruments.

Warranty

Surgivalley stainless steel instruments are warranted for a period of two (2) years from the original date of purchase. Surgical single patient products are warranted for 90 days against defects in workmanship or materials that are discovered prior to initial use or expiration. If instruments should fail as the result of a defect in materials or workmanship, Surgivalley is committed to take steps it believes are necessary to rectify the problem. These steps may include, but are not limited to, repair, replacement or supplying an alternative instrument. This warranty does not cover general maintenance such as cleaning and sharpening services required as a result of normal use. It does not include damage that is caused by misuse, improper care, the use of improper chemicals or cleaning methods, negligence, modification or unauthorized service by non-Surgivalley personnel, or normal wear. Damage to insulating coatings on electro-surgical instruments is excluded from the terms of this warranty.

The sole remedy under this warranty shall be repair or replacement as provided above at the sole discretion of Surgivalley Instruments. In no event will Surgivalley be liable for any damages arising out of loss of use, or any other incidental or consequential damages. The foregoing limited warranty is in lieu of any other warranty with respect to Surgivalley products. Surgivalley grants no other warranty, express or implied.

Description	Page	Description	Page	Description	Page
JANSEN-MIDDLETON Nasal Cutting Forceps	43	MAYO-NOBLE Dissecting Scissors	54	R	
Jeweller's Forceps	71	McCOLLOUGH Elevator	33	RAGNELL Retractors	10
JONES Towel Clamps	77	McCOLLUM-DINGMAN Breast Dissectors	16	RAGNELL-DAVIS Retractor	10
JOSEPH Button End Knife	88	McCOLLUM-DINGMAN Submammary Dissector		RALK Splinter Forceps	72
JOSEPH Nasal Rasps	45	McCoy Micro Dermal Hook	12	RANKIN-CRILE Hemostatic Forceps	75
JOSEPH Nasal Saws	88	McINDOE Tissue Forceps	69	REES Face-Lift Scissors	57
JOSEPH Nasal Scissors	58	McKENTY Elevators	34	REES Osteotome	35
JOSEPH Periosteal Elevator	34	McKISSOCK (COLLYER) Caliper	28	REYNOLDS Tenotomy & Facelift Scissors	59
JOSEPH Skin Hooks	12	McKISSOCK Keyhole Markers/Calipers	27	REYNOLDS Transauxillary Breast Dissectors	17
JULIAN MOSQUITO Forceps	74	McPHERSON Suture Forceps	70	RIBBON Retractors	7
K		MEAD Mallet	37	RICHARDSON-EASTMAN Retractors	7
KASDEN Retractor	11	Medicine Cup	90	RISTOW Rhinoplastic Chisels	35
KAYE Blepharoplasty Scissors	60	MERCEDES Liposuction Cannulas	93	ROCHESTER-PEAN Hemostatic Forceps	75
KAYE Face-Lift Scissors	56	Metal Rulers	28	ROLLET Rake Retractor	13
KAYE-FREEMAN Face-Lift Scissors	56	METZENBAUM Dissecting Scissors	55	ROWE Zygomatic Bone Elevators	33
KELLY Hemostatic Forceps	74	METZENBAUM Fino Dissecting Scissors	55	RUBIN Septal Morselizers	43
KELLY Scissors	54	Micro Cannulas	96	RUBIN Type Osteotomes	36
KILLIAN Nasal Speculas	40	Micro Dressing and Suture Forceps	71	RUSKIN-LISTON Bone Cutting Forceps	49
KILNER Dissecting Scissors	54	Micro Needle Holders	84		
KILNER Skin Hook	13	Micro Scissors, with round handle	64	S	
KLEINERT KUTZ Hooklets	12	Micro Vascular Needle Holders	83	Scalp Elevators	20
KLEINERT-KUTZ Bone Cutting Forceps	49	Micro Vessel Dilating Forceps	71	Scalp Elevators	21
Knife Handle, for plastic surgery	24	Midface Facial Dissectors	23	Scalpel Handle, round	88
KNIGHT Nasal Scissors	58	MILLARD (ADSON) Hooks Forceps	10	Scalpel Handles	87
KNOWLES Bandage Scissors	63	MILLER Rake Retractor	13	Scalpel handles, round	88
KOCHER (OCHSNER) Hemostatic Forceps	75	MILLER-COLBOURNE Bone Files	46	SCHAMBERG Comedon Extractors	32
KOTZUR Liposuction Cannulas	93	MINI-FRIEDMAN Bone Rongeurs	48	SEALY Scissors	60
L		Mirco Suture Tying Forceps	71	SEMKEN Dressing Forceps	68
LAHEY Vulsellum Forceps	77	MITCHELLS Trimmer/Elevator	33	SENN Retractors	11
LAMBOTTE Osteotomes	36	MIXTER Hemostatic Forceps	76	SHEA Fine Scissors	60
Lead Hand	7	Multi Approach Retractor	4	SHEEHAN Osteotomes	36
LED Headlight Portable	100	N		SHEEN Grid	29
LEMMON Needle Holders	83	Needle Nose Pliers	52	SHEEN PARKES Nasal Retractor	11
LEMPERT Bone Rongeurs	48	NEIVERT (OFFSET) Needle Holder	81	SHEEN Radix Chisels	36
LEWIS Nasal Rasps	44	NEIVERT Rhinoplastic Chisels	35	SHEEN Retractor	11
LEXER-BABY Dissecting Scissors	55	Nerve Cutting Knife	24	SHEEN-KILLIAN Septum/Nasal Forceps	41
Light Source Side Adapter	102	Nerve Dissector	24	SIEGEL Knife Handle, round	88
Liposuction Cannulas	92, 93-94	Nerve Hooks	24	SILVER Dermatome	89
LISTER Bandage Scissors	63	Nerve Hooks	24	SILVER Rhinoplastic Chisels	34
LISTON Bone Cutting Forceps	49	Nerve Protectors	23	Solution Bowl	90
LITTAUER Cilia Forceps	72	O		Spatulated Dissector	16
LITTAUER Stitch Scissors	62	O'BRIEN Stitch Scissors	63	SPENCER Stitch Scissors	63
LITTLER Stitch Scissors	62	O'CONNOR (IRIS) Hooks	12	Splinter Forceps	72
LOCKWOOD Abdominal Demarcator	28	OBWEGESSER Periosteal Elevators	34	Sponge Bowl	90
LOGAN Bow Lip traction Retractors	10	OEHLER Dressing Forceps	68	STEVENS Tenotomy Scissors	59
LORNA-EDNA Towel Clamp	77	OLSEN HEGAR Needle Holders	82	Stop for Syringes	97
LUCAE Bone Mallet	38	Operating Scissors	54	STRABISMUS Scissors	60
LUCAE Ear Polypus Forceps	69	Orbital Rim Dissector	22	Suction Adapter for Lure lock	97
M		P		SWEDISH Needle Holder	82
MALINIAC Nasal Retractors	5	PAR Forceps	67	Syringe Stand for Lure Lock	97
Mallet	37	PAR Needle Holders	81	T	
Mallet (Nylon / Steel)	37	PAR Scissors	62	TAKAHASHI (WATSON-WILLIAMS) Nasal Cutting Forceps	41
Mallet (Nylon)	38	PARKES Gouge	35	TAYLOR Forceps	68
MALTZ Nasal Rasps	44	PARKES Lateral Osteotome	36	TEBBETS Style Retractors	2
MARTEN Flap Markers	28	PARKES Nasal Rasps	44	Temporal T- Dissector	22
MARTINEZ KILNER Retractors	10	Periosteal Elevators	22	Thimble Hooks	10
MARTINI Bone Spoon	32	Periosteal Spreaders	22	THORPE (MARCHAC) Calipers	30
MAXWELL FLAP Retractors	9	PITANGUY Facial Demarcators	27	TOLEDO Liposuction Cannulas	92
Dissecting Scissors	54	PITANGUY Flap Grasping Forceps	27	TOLSDORF Cartilage Crusher	43
Needle Holders	82	POTTS-SMITH Dressing Forceps	68	Transoral Dissectors	23

Description	Page
Transumbilical Breast Augmentation	18
Trocar Breast Tubes	19 . .
TROELTSCH (WILDE) Ear Polypus Forceps. . .	69
TYRELL Skin Hook	12 . .
U	
Universal Flat Nose Pliers	52 .
Universal Wire Scissors	62 .
UNNA Comedon Extractors	32 .
US ARMY (PARKER LANGENBECK) Retractors .	7
USA MODEL Tubing Clamps	78.
Utility scissors.	63. . .
V	
VANNAS Micro Scissors.	64 .
VIENNA Nasal Speculas	40 .
V-Shaped Breast Dissector.	19 .
W	
WALSHAM Septum Straightening Forceps. . .	41
WALTER-CARMALT Splinter Forceps	72
WATSON Dermatome.	89. .
WEBSTER (BABY) Needle Holders.	80
WEBSTER Needle Holders	80 .
WEIL-BLAKESLEY (WILDE) Nasal Cutting Forceps	41
WEITLANER BABY Retractors.	14.
WEITLANER Retractors.	14 .
WESTCOTT Micro Scissors	64 .
WESTCOTT Stitch Scissors	64 .
WIEDER Tongue Depressors	4. .
WILKINSON Face-Lift Scissors.	57.
WILLIGER Bone Spoon	32 .
WILLIGER Elevator	33 .
WILMER Conjunctival and Utility Scissors . .	61
Wire & Pin Face and Side Cutter	51
Wire & Pin Side Cutter	51. .
Wire & Pin Side Cutter	51. .
Wire Flat Pliers	52 .
Wire Seizing Forceps	52. .
Wire Twisters	50. .
WOODSON Elevator	33. .
Y	
YANCOSKIE Abdominoplasty Retractor	9
YANKAUER Suction Tubes.	86.
Z	
Zygomatic Arch Elevator	22 .



TI- BI-2003-00



TI- BI-2004-00



TI- BI-2005-00

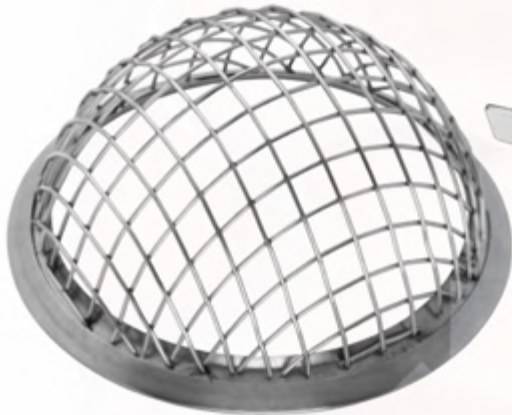

TI- BI-2006-00

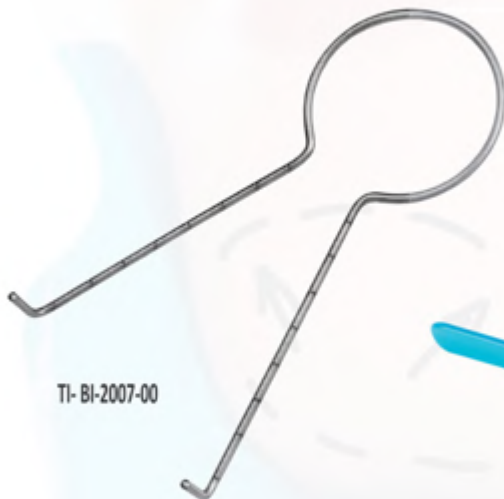

TI- BI-2007-00



TI- BI-2008-00



TI- BI-2009-00

get the look
& *confidence*
you have been looking for



Head Office : Gunjianwali Khurd P.O Sialkot - 51310 Pakistan.

 +92-346-6627512 Cell : +92-320-1204668

E-mail : shafique.tiadoc@gmail.com

Website: www.taidocintl.com

